

TomTom RIDER

1. What's in the box

Ⓐ Your TomTom RIDER

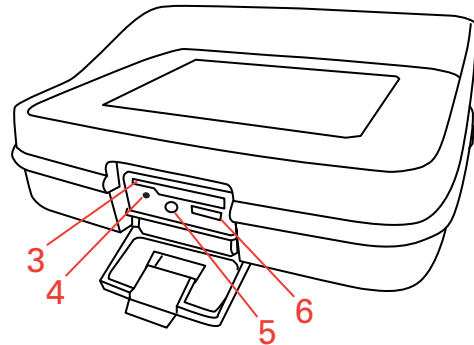
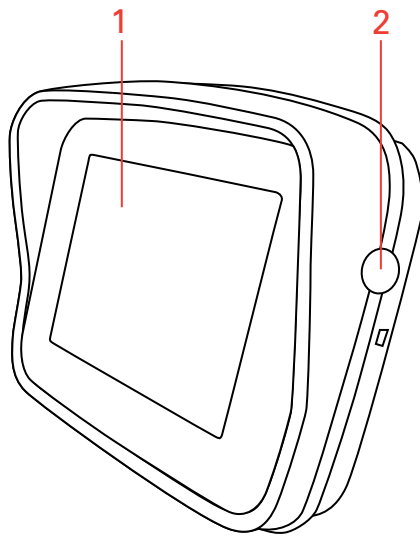

- ① Touchscreen
- ② On/Off button
- ③ Memory card (SD card) slot
- ④ USB connector
- ⑤ Charging connector
- ⑥ Reset button

Ⓑ A memory card (SD card)

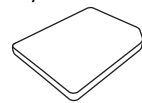

Ⓒ Cardo scala-rider™ Bluetooth® headset

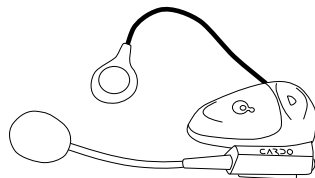

Ⓓ RAM Mount™ mounting kit

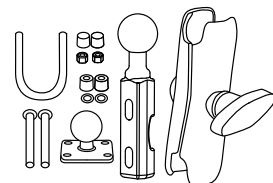

Ⓔ Holder and security strap

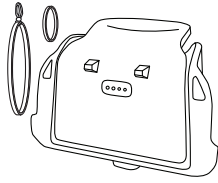

Ⓕ TomTom RIDER case

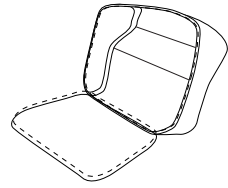

Ⓖ Home Charger

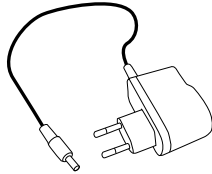

Ⓖ Documentation pack

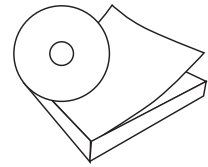

Ⓖ Battery cable

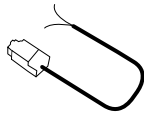

Ⓖ USB cable

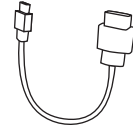

2. Using your TomTom RIDER

Switching on

1. Open the compartment on the bottom of your TomTom RIDER.
2. Push the memory card into the memory card slot.

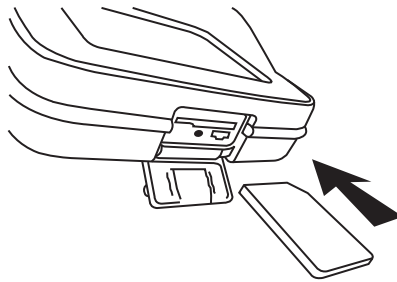

3. Press and hold the On/Off button for 2 seconds, or until your TomTom RIDER starts.

The first time you switch on your TomTom RIDER, it may take up to 20 seconds to start. To switch off your TomTom RIDER, press and hold the On/Off button for 2 seconds.

Setting up

First, you have to answer a few questions to set up your device and your Cardo scala-rider™ headset. Answer the questions by tapping the screen. You will use the touchscreen for everything you do with your TomTom RIDER.

Follow the instructions to establish a Bluetooth connection between your TomTom RIDER and your Cardo scala-rider™ headset.

Once you have answered the questions, your TomTom RIDER will display the Driving View.

The screen is shown in black and white until your TomTom RIDER locates your current position.

Charging your TomTom RIDER

Before you use your RIDER for the first time, it's a good idea to charge it fully using the home charger, which takes about 2 hours.

There is no charging light on your RIDER. To check the battery status and see when your RIDER is charging, switch on your device and tap the bottom right-hand corner of the screen in the Driving View. The battery status is shown on the next page.

Cardo scala-rider™ headset

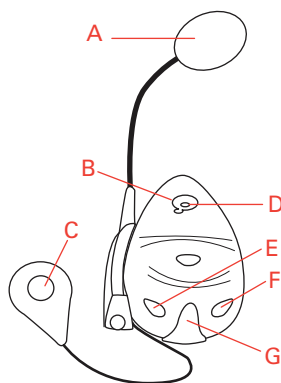

- Ⓐ Microphone
- Ⓑ On/Off button
- Ⓒ Speaker
- Ⓓ LED
- Ⓔ Volume down
- Ⓕ Volume up
- Ⓖ Charging connector

Before you can use your Bluetooth headset, fully charge the headset using the charger supplied with the headset.

Note: Make sure you use the correct charger. There are different chargers for your TomTom RIDER and your headset. Using the wrong charger may damage the device.

To fully charge the headset takes between 2 and 3 hours. When charging, the LED is a steady red. When charging is finished, the LED turns off.

When the batteries are running low, an alert tone is played.

Using your headset

To turn the headset on, press and hold the on/off button for 6 seconds, until the LED flashes blue 3 times. An ascending alert tone is played. When the headset is on, the LED flashes blue every 3 seconds.

To turn the headset off, press and hold the on/off button for 3 seconds, until the LED flashes red 3 times. A descending alert tone is played.

If you did not establish a Bluetooth connection between your Bluetooth headset module and your TomTom RIDER when you first turned your RIDER on, you can establish the connection at any time.

From the Main Menu, tap **Change Preferences**. Tap **Connect to headset** and follow the instructions to establish the connection.

Attach your headset to your helmet as shown in the Installation Poster. Make sure you position the microphone correctly. For best results, don't position the microphone directly in front of your mouth, position it just to the side of your mouth.

Locating your current position

Your TomTom RIDER must be outside to be able to locate your current position. Make sure that you are in an open place without tall buildings or trees around you.

The first time you start your RIDER, it can take a few minutes for the device to find your current position. In the future, your position will be found much faster, normally within a few seconds.

Your RIDER does not transmit your location, so others cannot use it to track you while you are driving.

TomTom RIDER uses a GPS receiver to locate your current position.

Mounting your navigation device

Attach the RAM™ mount kit to your motorcycle as shown on the Installation Poster, then place your RIDER in the holder. When you are attaching the mount kit to your motorcycle, follow these guidelines:

- If you are unsure about attaching the mount kit yourself, ask a professional to fit it for you.
- Make sure that the mount kit does not interfere with any of the controls on the motorcycle.
- Always use the correct tools. If you use unsuitable tools, you may damage or break the mount kit.
- Do not overtighten nuts. You may crack parts of the mount kit or damage your handlebars if you overtighten the nuts.
- If you are using the u-bolt, don't forget to put the rubber caps provided over the exposed threads.

Damage due to modifications, improper installation, road hazards or accident, are not covered. Neither RAM nor TomTom shall be liable for any injury, loss, or damage, direct or consequential, arising out of improper installation, or inability to use the product. Before use, the user shall determine the suitability of the product for its intended use. The user assumes all risk and liability, whatsoever, in connection with the mount.

Secure your TomTom RIDER

Set a password for your TomTom RIDER so that only you can use it. Every time you start your RIDER you will have to enter your password.

To set the password, you have to run your RIDER using TomTom HOME. You can then use TomTom HOME to set the password. To set a password on your device, do the following:

1. Connect your RIDER to your computer and switch it on.
2. Start TomTom HOME if it does not start automatically.

If you do not have TomTom HOME installed, insert the CD that came with your RIDER to install it.

Alternatively, you can download TomTom HOME from www.tomtom.com. Make sure you always have the latest version of TomTom HOME.

3. In the Planning section, select your RIDER.

A picture of your RIDER is shown in the main section of TomTom HOME.

4. Click the On/Off button on the picture of your RIDER to switch it on in TomTom HOME.

Your RIDER starts in TomTom HOME. You can now set the password on your RIDER using TomTom HOME. Don't unplug your RIDER, just use it as you normally would by clicking the buttons shown on your computer.

5. From the Main Menu in your device, click **Change preferences**.
6. Click **Set owner**. You may have to click the arrow until you reach the page where **Set owner** is shown.



Set owner

If you cannot find the button **Set owner**, make sure that all buttons are shown in your RIDER. Tap the button **Show ALL menu options**. All buttons will now be shown.

You can now set the password for your RIDER. You can also set your name and address, which will then be shown when your RIDER starts up.

Take care of your navigation device

It is important to take care of your RIDER and to clean it correctly.

- Use a soft cloth to wipe the screen of your RIDER; do not use any liquid cleaners.
- If your RIDER gets wet, dry it with a soft cloth.
- Do not open the casing of your RIDER under any circumstances. Doing so may be dangerous and will invalidate your warranty.
- Do not use the memory card (SD card) with any device other than a TomTom device. Other devices may damage the memory card.
- Do not expose your RIDER to high or low temperatures, which can cause permanent damage. For example, don't leave it on your motorcycle or in the car on hot summer days or during cold winter nights.

Backup your navigation device

It's always a good idea to make a backup of the contents of your TomTom RIDER. You can make a backup using TomTom HOME. You can install TomTom HOME using the CD that came with your TomTom RIDER.

3. Making your first trip

Planning a route with your TomTom RIDER is easy. To plan your first route, follow the steps below.

Important: You have to plan your trip before you start riding. For safety, once you start moving only the Safety Driving Menu is shown.

1. Tap the screen to bring up the main menu.

Note: The buttons on your RIDER are shown in full color unless a button is currently unavailable. For example, the button named **Find alternative...** in the Main Menu is not available until you have planned a route.

2. Tap **Navigate to...**

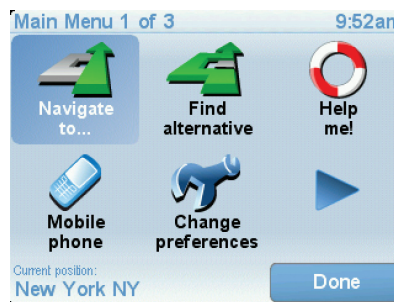

3. Tap **Address**.

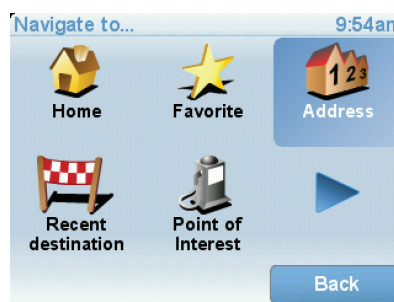

When you enter an address, you can choose from the following options:

- **City center** - tap this button to set your destination as the center of a city or town.
- **Street and house number** - tap this button to set an exact address as your destination.
- **ZIP code** - tap this button to enter a ZIP code as your destination.
- **Cross street or intersection** - tap this button to set your destination as the point where two streets meet.

In this example, we will enter an exact address.

4. Tap **Street and house number**.



Note: When planning a trip for the first time your RIDER asks you to choose a state or country. Your choice is saved and used for all routes you plan.

You can change this setting at any time by tapping the state symbol or country flag.

5. Start to type the name of the town where you want to go.



As you type, the names of the towns that match what you have typed are shown. When your destination appears in the list, tap the name of the town to set the destination.

6. Start to type the name of the street and select it when it is shown.

As with the name of the town, the names of the streets that match what you have typed are shown. When your destination appears in the list, tap the name of the street to set the destination.

7. Now enter the house number of your destination and then tap **Done**.

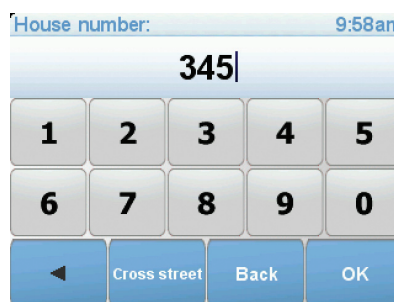

8. Your RIDER asks if you need to arrive at a particular time. For this exercise, tap **NO**.

The route is calculated by your RIDER.

9. When the route has been calculated, tap **Done**.

Your RIDER will immediately begin to guide you to your destination, using both spoken instructions and on-screen directions.



Arrival times

When you plan a route, your TomTom RIDER asks you if you need to arrive at a particular time.

Tap **YES** to enter a preferred arrival time.

Your RIDER calculates your arrival time and shows you whether you will arrive on time.

You can also use this information to work out when you need to leave. If your RIDER shows that you will arrive 30 minutes early, you can wait and leave in 30 minutes time, rather than arrive early.

Your arrival time is constantly recalculated during your trip. The status bar shows whether you will arrive on time or if you are going to be late, as shown below:

+55 min

You will arrive 55 minutes before the arrival time you entered.

If the estimated arrival time is more than five minutes before the time you entered, it is shown in green.

+3 min

You will arrive 3 minutes before the arrival time you entered.

If the estimated arrival time is less than 5 minutes before the time you entered, it is shown in yellow.

-19 min

You will arrive 19 minutes late.

If the estimated arrival time is later than the time you entered, it is shown in red.



Status bar preferences

Tap **Status bar preferences** in the Preferences menu, to enable or disable arrival time notifications.

Select the required options on the first menu screen and then tap **Done**.

To enable arrival time notifications, select **Show leeway to arrival time**.

To disable arrival time notifications, unselect **Show leeway to arrival time**.

What are the other navigation options?

When you tap **Navigate to...**, you can set your destination in many ways, not just by entering the address. The other options are listed below:



Home

Tap this button to navigate to your Home location.

You will probably use this button more than any other.



Favorite

Tap this button to select a Favorite as your destination.



Address

Tap this button to enter an address as your destination.



Recent destination

Tap this button to select your destination from a list of places you have recently used as destinations.



Point of Interest

Tap this button to navigate to a Point of Interest (POI).



My location

Tap this button to select your GPS position, as your destination.



Point on map

Tap this button to select a point on the map as your destination using the map browser.



Latitude Longitude

Tap this button to enter a destination using latitude and longitude values.



TomTom Buddy

Tap this button to navigate to the current position of a TomTom Buddy. Don't forget that the Buddy may move before you reach him.

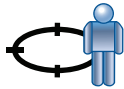

Position of last stop

Tap this button to select your last recorded position, as your destination.

Planning a route in advance

You can also use your RIDER to plan trips in advance by selecting both your starting point and your destination. You could, for example, do the following:

- Find out how long a trip is going to take before you start.
- Check the route of a trip you are planning.
- Check a route for someone who is coming to visit you so you can explain the route to them.

To plan a route in advance, follow these steps:

1. Tap the screen to bring up the main menu.
2. Tap the arrow button to move to the next menu screen and tap **Prepare route**.



Prepare route

3. Select the starting point for your trip in the same way that you would select your destination.
4. Set the destination for your trip.
5. Choose the type of route that should be planned.
 - **Fastest route** - the route which takes the least time.
 - **Shortest route** - the shortest distance between the locations you set. This may not be the quickest route, especially if the shortest route is through a town or city.
 - **Avoid freeways** - a route which avoids freeways.
 - **Walking route** - a route designed for making the trip on foot.
 - **Bicycle route** - a route designed for making the trip on a bicycle.
 - **Limited speed** - a route for a vehicle which can only be driven at a limited speed. You have to specify the maximum speed.
6. Your TomTom RIDER plans the route between the two locations you selected.

More information about a route

You can access these options for the route you last planned, by tapping **View route** in the Main Menu.

To find out about your route in detail, tap the **Details** button on the route summary screen.

You can then select from the following options:



Browse as text

Tap this button for a list of all the turn instructions on the route.

This is very useful if you need to explain a route to someone else.



Browse as images

Tap this button to see each turn in the trip. Tap the right and left arrows to move forwards and backwards through the trip.

Tap the screen to turn off the 3D display and view the map from above.



Browse map of route

Tap this button to see an overview of the route using the map browser.



Show route demo

Tap this button to watch a demo of the trip. You can interrupt the demo at any time by tapping the screen.



Show route summary

Tap this button to open the route summary screen.

4. Driving View

When your TomTom RIDER starts, you are shown the Driving View along with detailed information about your current location.

Tap the center of the screen at any time to open the Main Menu.

Note: The Driving View is shown in black and white until your RIDER locates your current position.



- Ⓐ Tap + and - to zoom in and out.
- Ⓑ Quick menu - switch this on in the Preferences menu.
This is only shown when you use your TomTom RIDER in a car.
- Ⓒ Your current position.
- Ⓓ The name of the next major road or road sign information, if applicable.
- Ⓔ Navigation instruction for the road ahead.
Tap this area to repeat the last spoken instruction and to change the volume.
- Ⓕ The name of the street you are on.
- Ⓖ Information about your trip such as trip time, remaining distance and arrival time.
To change the information shown, tap **Status bar preferences** in the **Preferences** menu.
- Ⓗ GPS signal strength.
- Ⓘ Traffic bar - requires a Bluetooth®-enabled mobile phone. For more information about how to subscribe to and receive TomTom Traffic, go to tomtom.com/traffic.

To set up Traffic information, tap the Traffic bar to open the Traffic menu or tap **TomTom Traffic** in the Main Menu.

5. Menus

Main menu

Tap the screen at any time when TomTom RIDER displays the Driving View to open the Main Menu.



- **Navigate to...**
Tap this button to start planning a route.
- **Find alternative...**
Tap this button if you want to avoid part of your route, travel via a specific location or calculate an alternative route.
- **Help me!**
Help me! provides an easy way for you to find and contact emergency service centers and other special services.
- **Mobile phone**
This button opens the mobile phone menu. You can, for example, make calls, and write or read messages.
- **Change preferences**
This button opens the Preferences menu. You can change many things about the way TomTom RIDER looks and behaves.

Hidden buttons and features

When you first start using your TomTom RIDER, not all the buttons will be shown in the menu.

Many buttons and some more advanced features are hidden because you will not need these features very often.

To show all buttons and features, tap **Show ALL menu options** in the Preferences menu.

To hide these buttons again, tap **Show fewer menu options** in the Preferences menu.

Safety Driving Menu

If you tap the screen when you are riding, the Safety Driving Menu is shown. When you use your RIDER in a car, this menu is not shown.

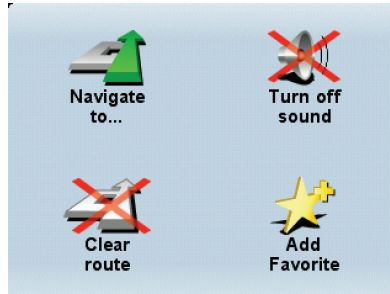

- **Navigate to...**

Tap this button to select a destination.

- **Turn off sound / Turn on sound**

Tap this button to turn the spoken instructions on or off.

- **Clear route**

Tap this button to delete the route that is currently planned. The Driving View still shows your position.

- **Add favorite**

Tap this button to add your current location as a favorite. Your TomTom RIDER uses the address of your current location as the name of the favorite. You can change the name of the favorite at any time by tapping **Manage favorites** in the Preferences menu.

Customize the Safety Driving Menu

You can change the **Add favorite** button to another button that is more useful for you. In the Preferences menu, tap **Safety driving menu** then select the button to show here.

6. Finding alternative routes

Once you have planned a route, you may want to change something about the route, without changing your destination.

Why change the route?

Maybe for one of these reasons:

- You can see a roadblock or a line of traffic ahead.
- You want to travel via a particular location, to pick someone up, stop for lunch or fill up with gas.
- You want to avoid a difficult intersection or a road you don't like.



Find alternative...

Tap **Find alternative...** in the Main Menu to change the route that is currently planned.

Then tap one of the options below.



Calculate alternative

Tap this button to calculate an alternative to the route already planned.

Your RIDER will look for another route from your current location to your destination.

If you decide you would prefer to use the original route after all, tap **Recalculate original**.

Why would I need to do this?

Apart from the roads near your position and near your destination, the new route will use totally different roads to reach your destination. This is an easy way of calculating a totally different route.



Avoid roadblock

Tap this button if you can see a roadblock or a line of traffic ahead. You then have to choose how much of the route ahead you want to avoid.

Choose from the different options: 100m, 500m, 2000m, 5000m. Your RIDER will recalculate your route avoiding the section of the route for the distance you selected.

Don't forget that once a new route is calculated, you may have to turn off the road you are on very soon.

If the roadblock suddenly clears, tap **Recalculate original** to return to your original route.



Travel via...

Tap this button to change your route so that it passes a particular location, perhaps to pick someone up on the way.

You choose the location you want to pass in the same way as you choose a destination. So you can select from all the same options: for example, **Address, Favorite, Point of Interest** and **Point on map**.

Your RIDER will calculate a new route to your destination that passes the location you chose.

Using this button, you can only travel via one location. If you want to pass more than one, use an Itinerary.



Recalculate original

Tap this button to return to the original route without deviations to avoid roadblocks or traveling via particular locations.



Avoid part of route

Tap this button to avoid a part of the route. Use this button if you see that your route includes a road or junction you don't like, or which is well-known for traffic problems.

You then choose the road you want to avoid from a list of the roads on your route.



Minimize traffic delays

Tap this button to recalculate your route so that it avoids traffic problems as much as possible. Your RIDER will check if there are any traffic problems on your route and work out the best route to avoid the problems.

7. Browse map

To look at the map in the same way as you might look at a traditional paper map, tap **Browse map** in the Main Menu.

You can move the map by touching the screen and moving your finger across the screen.

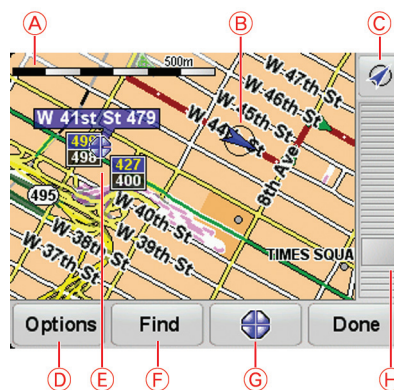

Ⓐ The scale bar

Ⓑ Your current position.

Ⓒ GPS button

Tap this button to center the map on your current position.

Ⓓ Options

Ⓔ The cursor

Ⓕ The Find button

Tap this button to find specific addresses.

Ⓖ The Cursor button

Tap this button to navigate to the cursor position, make a Favorite of the cursor position, or find a Point of Interest near the cursor position.

Ⓗ The zoom bar

Zoom in and out by moving the slider.

Cursor button

You can use the map to find addresses and Points of Interest (POIs), for example, restaurants, train stations and gas stations.

Tap the cursor button then tap one of the following buttons:



Navigate there

Tap this button to navigate to the cursor position. Your RIDER will calculate the route.



Find POI nearby

Tap this button to find a POI near the cursor position. For example, if you have found a restaurant to go to, you can search for a parking garage nearby.



Center on map

Tap this button to bring the location currently highlighted by the cursor to the center of the screen when looking at the map.



Call...

Tap this button to call the location at the cursor position. This button is only available if your RIDER has the phone number for the location.

The phone numbers of many POIs are stored in your RIDER. If you enter phone numbers for POIs that you create, you can also call them.



Add as Favorite

Tap this button to create a Favorite at the cursor position.



Add as POI

Tap this button to create a POI at the cursor position.



Correct location

Tap this button to correct the location shown at the cursor position.

8. Favorites

What are Favorites?

Favorites are places that you often visit. You can create Favorites so that you don't have to enter the address every time you want to navigate there.

They don't have to be places you especially like, just useful addresses.

How can I create a Favorite?

From the Main Menu, tap **Add Favorite**.

Note: The button **Add Favorite** may not be shown on the first page of the Main Menu. Tap the arrow to open other pages in the Main Menu.

You can then select the location of the Favorite from the list below.

Give your Favorite a name that is easy to remember. Your RIDER will always suggest a name, usually the address of the Favorite. To enter the name, just start typing. You don't have to delete the suggested name.



Home

You can set your Home location as a Favorite.



Favorite

You cannot create a Favorite from another Favorite. This option will always be unavailable in this menu.

To rename a Favorite, tap **Manage Favorites** in the Preferences menu.



Address

You can specify an address to be a Favorite. When you enter an address, you can choose from four options.

- **City center**
 - **Street and house number**
 - **ZIP code**
 - **Crossing or intersection**
-



Recent destination

Select a Favorite location from a list of places you have recently used as destinations.



Point of Interest

You can add a Point of Interest (POI) as a Favorite.

Does it make sense to do this?

If you visit a POI you particularly like, for example a restaurant, you can add it as a Favorite.

To add a POI as a Favorite, tap this button, then do the following:

1. Narrow your choice of POIs by selecting the area where the POI is.

You can select one of these options:

- **POI near you** - to search from a list of POIs near your current position.
- **POI in city** - to choose a POI in a particular town or city. You have to specify a town or city.
- **POI near Home** - to search from a list of POIs near your Home location.

If you are currently navigating to a destination, you can also select from a list of POIs which are on your route or near your destination. Choose one of these options:

- **POI along route**
- **POI near destination**

2. Select the category of POI.

Tap the category of POI if it is shown or tap the arrow to choose from the complete list.

Tap **Any POI category** to search for a POI by name.



My location

Tap this button to add your current position as a Favorite.

For example, if you stop somewhere interesting, while you are there you can tap this button to create the Favorite.



Point on map

Tap this button to create a Favorite using the map browser.

Select the location of the Favorite using the cursor, then tap **Done**.



Latitude Longitude

Tap this button to create a Favorite by entering latitude and longitude values.



TomTom Buddy

Tap this button to make a Favorite of the current position of a TomTom Buddy.



Tap this button to select your last recorded position as your destination.

How can I use a Favorite?

You will normally use a Favorite as a way of navigating to a place without having to enter the address. To navigate to a Favorite, do the following:

1. Tap the screen to bring up the main menu.
2. Tap **Navigate to...**
3. Tap **Favorite**.
4. Select a Favorite from the list.

Your RIDER calculates the route for you.

5. When the route is calculated, tap **Done**.

Your RIDER will immediately start guiding you to your destination with spoken instructions and visual instructions on the screen.

How can I delete a Favorite?

1. Tap the screen to bring up the main menu.
2. Tap **Change preferences** to open the Preferences menu.
3. Tap **Manage Favorites**.

Tip: Tap the arrow to move to the next page.

4. Tap the Favorite you want to delete.
5. Tap **Delete**.

How can I change the name of a Favorite?

1. Tap the screen to bring up the main menu.
2. Tap **Change preferences** to open the Preferences menu.
3. Tap **Manage Favorites**.

Tip: Tap the arrow to move to the next page of buttons.

4. Tap the Favorite you want to rename.
5. Tap **Rename**.

9. Points of Interest

Points of Interest or POIs are useful places on the map. Here are some examples:

- Restaurants
- Hotels
- Museums
- Parking garages
- Gas stations

Showing POIs on the map

1. Tap **Show POIs on map** in the Preferences menu.



2. Select the POI categories to display on the map.

Tap **Find** to search for a POI by name.

3. Tap **Done**.

The POIs you have selected are shown as symbols on the map.

Navigating to a POI

You can use a POI as your destination. For example, if you are traveling to an unfamiliar city, you could choose a POI to help find a parking garage.

1. Tap the screen to bring up the main menu.
2. Tap **Navigate to...** in the Main Menu.
3. Tap **Point of Interest**.
4. Tap **POI in city**.
5. Narrow your choice of POIs by selecting the area where the POI is located.

You can select one of these options:

- **POI near you** - to choose from a list of POIs near to your current location.
- **POI in city** - to find a POI in a particular town or city.
- **POI near Home** - to choose from a list of POIs near to your Home location.

You can select from a list of POIs which are along your route or close to your destination. Choose from one of these options:

- **POI along route**
- **POI near destination**

6. Type the name of the town you want to visit and select the town when it appears in the list.

7. Tap **Parking garage**.

8. Select the category of POI:

Tap **Any POI category** to search for a POI by name.

Tap the category of POI, if it is shown.

Tap the arrow to choose from the complete list of categories. Select the category from the list or start to type the name of the category and select it when it appears in the list.

9. Select a parking garage. The distance listed next to each POI is the distance from the city center.

10. From the list of POIs shown, select the POI you want to navigate to.

The table below explains the distances listed next to each POI.

POI near you	Distance from your current location
POI in city	Distance from the city center
POI near Home	Distance from your Home location
POI along route	Distance from your current location
POI near destination	Distance from your destination
Last POI	Distance to the last POI you visited

If you know the name of the POI, tap **Find** and type the name. Select it from the list when it is shown.

11. Select a parking garage. The distance listed next to each POI is the distance from the city center.

Once you have selected a POI, the route to the POI is calculated by your TomTom RIDER.

The route to the POI is then calculated by your TomTom RIDER.

Managing POIs



Manage POIs

Tap **Manage POIs** from the Preferences menu.

Note: The **Manage POIs** button is only available when all menu buttons are shown. To show all menu buttons, tap **Show ALL menu options** in the Preferences menu.

You can, for example, do the following:

- Create your own POI categories and add POIs to them.
- Set warnings when you get close to POIs.

Why would I want to create my own POIs?

A POI acts like a shortcut - once you have saved a location as a POI you never have to type the address of that POI again. But when you create a POI you can save more than just the location.

- Phone number - when you create a POI, you can save a phone number with it.
- Categories - when you create a POI you have to put it in a category.

For example, you could create a category of POIs called 'Favourite restaurants'. With each POI, save the phone number so that you can call them from your RIDER to reserve a table.

For example, you could create a category of POIs called 'Favourite restaurants'. With each POI, save their phone number so that you can call them to reserve a table.

How can I create my own POIs?

1. Tap the screen to bring up the main menu.
2. Tap **Change preferences**.
3. Tap **Manage POIs**.
4. Before you can add a POI, you have to create at least one POI category. Every POI is assigned to a POI category. You can only add POIs to POI categories you have created yourself.



Tap **Add POI category**.

5. Enter a name for your POI category, for example, 'Friends' or 'Favourite restaurants'. Then select a marker for your POI category.
6. Tap **Add POI**.



Tap this button to add a POI.

7. Select the POI category in which you want to add the POI.
8. Select the location of your POI from the list below.



Home

You can set your Home location as a POI.

If you want to change your Home location, you can create a POI of the Home location before you change it.



Favorite

You can create a POI from a Favorite.

You can only create a limited number of Favorites. If you want to create more Favorites you have to delete some Favorites first. Before you delete a Favorite, make it into a POI so that you don't lose the address.



Address

You can specify an address to be a POI. When you enter an address, you can choose from four options.

- **City center**
 - **Street and house number**
 - **ZIP code**
 - **Crossing or intersection**
-



Recent destination

Select a POI location from a list of places you have recently used as destinations.



Point of Interest

You can add a Point of Interest (POI) as a POI. For example, if you are creating a category of POIs for your favourite restaurants, use this option instead of entering the addresses of the restaurants.



My location

Tap this button to add your current position as a POI.

For example, if you stop somewhere you like, while you are there you can tap this button to create the POI.



Point on map

Tap this button to create a POI using the map browser.

Select the location of the POI using the cursor, then tap **Done**.



Latitude Longitude

Tap this button to create a POI by entering latitude and longitude values.



TomTom Buddy

Tap this button to make a POI of the current position of a TomTom Buddy.



Tap this button to select your last recorded position as your destination.

This may be useful if your RIDER is unable to maintain a strong GPS signal, for example, when you drive through a long tunnel.

How can I set warnings for POIs?

1. Tap the screen to bring up the main menu.
2. Tap **Change preferences**.
3. Tap **Manage POIs**.

Note: The **Manage POIs** button is only available when all menu buttons are shown. To show all menu buttons, tap **Show ALL menu options** in the Preferences menu.

4. Tap **Warn when near POI**.



Tap this button to receive a warning when you travel near to the location of a POI.

5. Select the category of POI you want to be warned about.

Select the category from the list or start to type the name of the category and select it when it is shown in the list.

6. Set how close the POI should be when you receive a warning.
7. Choose the warning sound for the category of POI you selected.

10. Itinerary Planning

What is an Itinerary?

An Itinerary is a plan for a trip including more locations than your final destination.

An Itinerary can include the following items:

- Destination - a location on your trip where you want to stop.
- Waypoint - a location on your trip you want to travel through without stopping.

Here's an example of an Itinerary:



Destinations are shown using this symbol.



Waypoints are shown using this symbol.

When would I use an Itinerary?

You could use an Itinerary for trips such as:

- A road trip through a country with lots of stops.
- A two day car trip with an overnight stop.
- A short drive which passes by Points of Interest.

In all these examples you could tap **Navigate to...** for each place. However, if you use an Itinerary, you can save time by planning everything in advance.

Creating an Itinerary

1. Tap the screen to bring up the main menu.

2. Tap **Itinerary planning**.



The Itinerary planning screen opens. At first, there are no items on the Itinerary.

Note: This button may only be available if all menu options are shown. To show all menu options, tap **Show ALL menu options** in the Preferences menu.

3. Tap **Add** and select a location.

Tip: You can add items to your Itinerary in any order and rearrange the order later.

Following an Itinerary

When you use an Itinerary to navigate, the route will be calculated to the first destination on the Itinerary. Your TomTom RIDER calculates the remaining distance and time to the first destination and not for the whole Itinerary.

As soon as you start to use an Itinerary, the route is calculated from your current position. You do not need to set a departure point.

When you have passed a waypoint or reached a destination, it is marked as visited.

Waypoints are shown on the map. Your RIDER will not warn you when you are approaching a waypoint or when you arrive at a waypoint.

Organizing an Itinerary

Tap an item on your Itinerary to open a page of buttons for editing the item. The buttons shown below are available.



You can change a waypoint into a destination using this button.

Remember that waypoints are points on your trip to your destination that you want to pass and destinations are places where you want to stop.

This button is only shown if the item you tapped is a destination.



You can change a waypoint into a destination using this button.

Remember that destinations are places where you want to stop, and waypoints are points on your trip to your destination that you want to pass.

This button is only shown if the item you tapped is a waypoint.



Tap this button to miss out part of your Itinerary. Your RIDER will ignore this item and all the items before it in the Itinerary.

It will navigate you to the next item in the Itinerary.

This button is only shown if you are still due to visit this item.



Mark 'to visit'

Tap this button to repeat part of your Itinerary. Your RIDER will navigate you to this item followed by the rest of the items in the Itinerary.

This button is only shown if you have already visited this item.



Move item up

Tap this button to move the item up the Itinerary.

This button is unavailable if the item is at the top of the Itinerary.



Move item down

Tap this button to move the item down the Itinerary.

This button is unavailable if the item is at the bottom of the Itinerary.



Show on map

Tap this button to see the location of the item on the map.



Delete item

Tap this button to delete the item from the Itinerary.

Start Using an Itinerary

Tap **Options**, then tap **Start navigation**.

To save an Itinerary, tap **Save Itinerary**.

To load a saved Itinerary, tap **Load Itinerary**.

To create a new Itinerary, tap **New Itinerary** and to delete one, tap **Delete Itinerary**.

11. Hands-free calling

If you have a mobile phone with Bluetooth®, you can use your TomTom RIDER to make phone calls and send and receive messages.

Note: *Not all phones are supported or compatible with all features. For more information, go to tomtom.com/phones*

Connecting to Your Phone

First you must establish a connection between your mobile phone and your TomTom RIDER.

Tap **Mobile phone** in the **Main Menu** and then follow the instructions on the screen.

You only need to do this once, after which your TomTom RIDER will remember your phone.

Setting up TomTom Services

When you have established a connection with your phone, you can set up a wireless data connection for TomTom Services.

Tips

- Make sure that you switch on Bluetooth® on your phone.
- Make sure that your phone is set to "discoverable" or "visible to all".
- You may have to enter the password '0000' on your phone in order to connect to your TomTom RIDER.
- Make your TomTom RIDER a trusted device on your phone. Otherwise you will have to enter '0000' every time.

See your phone's user guide for information about Bluetooth® settings.

Your Phone Book

You can copy your phonebook from your mobile phone to your TomTom RIDER so that you can make calls with just a few taps on the screen.

This is the safest way to make hands-free calls.

Note: *You can copy your phonebook to your TomTom RIDER at any time. From the Mobile phone menu, tap **Get numbers from phone**.*

Not all phones can transfer their phonebook to your RIDER. For more information, visit www.TomTom.com/phones

Making a Call

Once you have established a connection with your phone, you can start making calls.

1. Tap **Mobile phone** in the Main Menu.
2. Tap **Call**.

Note: *Make sure that your phone is currently selected. The current phone is shown at the bottom of the screen.*

3. Tap **Number** to enter a number to call.
4. Do one of the following:
 - Tap **Home** to call your Home location. If you have not entered a number for your Home location this button is unavailable. To enter a number, tap **Change Home number** in the **Phone preferences** menu.
 - Tap **Number** to enter a number to call.
 - Tap **Point of Interest** to choose a Point of Interest (POI) to call. If your RIDER knows the phone number of a POI, this is shown next to the POI.
 - Tap **Phonebook entry** to select a contact from your phonebook.

Note: *If you have not copied your phonebook to your TomTom RIDER, the button **Phonebook entry** is unavailable.*

- Tap **Recently dialed** to select from a list of people or numbers you have called recently using your RIDER.
- Tap **Recent caller** to select from a list of people or numbers who called you recently. Only calls you have received on your RIDER are saved in this list.

Receiving a Call

If someone calls you while you are driving, accept or reject the call by tapping the screen.

Auto-Answer

You can tell your TomTom RIDER to answer every call automatically after a certain time. Tap **Phone preferences** in the mobile phone menu, then tap **Auto-answer preferences**.

Select when your TomTom RIDER will automatically answer your calls.

Sharing your TomTom RIDER

To add more phones, do the following. You can establish connections for up to 5 mobile phones.

1. Tap **Mobile phone** in the Main Menu.
2. Tap **Connect to your phone**.
3. Tap **Find other phone...** and follow the instructions on the screen.

To switch between phones, tap **Connect to your phone** and then select your phone from the list.

Mobile phone menu

The available buttons are listed below:



REDIAL

Tap this button to redial a telephone number using your mobile phone.



**Read/Write
message**

Tap this button to read or write a message.



**Phone
preferences**

Tap this button to configure how your TomTom RIDER communicates with your mobile phone.



Call...

Tap this button to dial a telephone number using your mobile phone.



**Get phone
numbers
from phone**

Tap this button to load the contacts and phone numbers from your mobile phone onto your TomTom RIDER.



**Manage
phones**

Tap this button to manage the mobile phones that will be connected to your TomTom RIDER. You can add a profile for up to five different mobile phones.

12. Preferences

Hidden buttons and features

When you first start using your TomTom RIDER, all the buttons are shown in the menu.

The buttons for the more advanced features can be hidden. This is a useful option because you are unlikely to use certain features very often.



Show fewer menu options

Tap this button in the Preferences menu, to reduce the number of buttons that are shown.

You might want to do this so that only frequently used buttons are shown.

When you need to use the buttons that are hidden, you can press **Show ALL menu options** in the Preferences menu to show all buttons.



Show ALL menu options

Tap this button in the Preferences menu, to show all the buttons available on your TomTom RIDER.

Use night colors / Use day colors



Use night colors

Tap this button to reduce the brightness of the screen and show darker colors on the map.

When should I use this?

When it's dark, it is easier to see the screen if the display on your RIDER is not brightly lit.



Use day colors

To change back to a brighter screen showing brighter colors on the map, tap **Use day colors**.

Can my RIDER make this change automatically?

Yes. Your RIDER has a light sensor to tell when it is getting dark.

To change to night and day colors automatically, tap **Brightness preferences** in the Preferences menu. Then select **Switch to night view when dark**.

Show POI on map



Show POI on map

Tap this button to set which categories for the Points of Interest (POIs) should be shown on the map.

Select the POIs that you want to see on the map from the list.

When you select a POI, it is shown on the map using the symbol you can see next to each category in the list.

To find a POI category quickly, tap **Find**, then start to type the name of the POI category. As soon as the category is shown in the list, you can select it.

Change 2D/3D display / Turn on 2D display



Turn on 2D display

Tap **Turn on 2D display** to change the perspective for viewing the map.

For example, the 2D view shows a two dimensional view of the map as though viewed from above.



Change 2D/3D display

To switch the view to a three dimensional perspective, tap **Change 2D/3D display** and select a view from the list.

When should I use this?

In some situations, it is easier to see the map from above. Perhaps if the road network is complicated or for times when you are walking while using your RIDER to navigate.

Voice preferences



Voice preferences

Tap **Voice preferences** to manage your TomTom voices. The following options are available:

- **Change voice** - tap this button to change the voice that gives you instructions.
A wide range of recorded human voices and computer voices are available.
- **Disable voice** - tap this button to disable the use of voices. To enable voices, tap **Enable**.
- **Download voice** - tap this button to download new voices from TomTom Services and transfer them to your TomTom.

Turn off sound / Turn on sound



Turn off sound

Tap this button to turn off spoken instructions.

The button changes to **Turn on sound**. If you turn off the sound, warnings for upcoming POIs are also turned off.

Tips

To change the volume, tap **Volume preferences** in the Preferences menu.

To change the volume quickly while you are driving, tap the bottom left-hand section of the Driving View and move the slider.

To change the voice being used by your RIDER, tap **Change voice** in the Voice preferences menu.

Can I still use my RIDER to make hands-free calls when the sound is turned off?

Yes. Turning the sound off does not affect hands-free calling, meaning that you will still be able to talk to and hear the caller.

Volume preferences

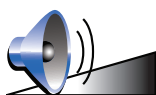

Volume preferences

Tap this button to change the volume for spoken instructions.

Manage Favorites



Manage Favorites

Tap this button to rename or delete Favorites.

To find a Favorite quickly, tap **Find**, then start to type the name of the Favorite. As soon as the Favorite is shown in the list, you can select it.

Change Home location



Change Home location

Tap this button to set or change your Home location.

Do I need to use my actual home address for the Home location?

No. Your Home location can be a place you go often, for example, your office. It can be your actual home address, but it can also be any address you like.

Why should I set a Home location?

Having a Home location means that you have a quick and easy way to navigate there, by tapping the Home button in the **Navigate to...** menu

Manage maps

This button may only be available if all menu options are shown. To show all menu options, tap **Show ALL menu options** in the Preferences menu.



Manage maps

Tap this button to do the following:

- **Download a map** - you can buy new maps using TomTom HOME.
- **Switch map** - tap this button to change the map you are using.
- **Download free map corrections** - tap this button to download map corrections from other users.
- **Delete a map** - tap this button to delete a map. This might be necessary to create more space on your RIDER, for example when you want to load a different map.

Note: *Don't delete a map unless you have already made a backup of the map. If you delete a map before you make a backup, you will no longer be able to load the map on your RIDER.*

Use TomTom HOME to make backups, download, add and delete maps from your navigation device.

Manage POIs

This button may only be available if all menu options are shown. To show all menu options, tap **Show ALL menu options** in the Preferences menu.



Manage POIs

Tap this button to do the following:

- Set alerts for when you are near POIs.
For example, your RIDER can tell you when there is a gas station nearby.
- Create your own POI categories and add POIs to them.

For example, you could create a category of POIs called "Friends", and add all your friends' addresses as POIs in the category. You can even add your friends' phone numbers with their address so you can call them from your RIDER.

Change car symbol

This button may only be available if all menu options are shown. To show all menu options, tap **Show ALL menu options** in the Preferences menu.

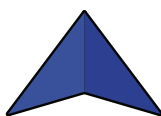

Change car symbol

Tap this button to select a car symbol that will be used to show your current position in the Driving view.

Status bar preferences

This button may only be available if all menu options are shown. To show all menu options, tap **Show ALL menu options** in the Preferences menu.



Status bar preferences

Tap this button to select the information shown on the status bar:

- **Remaining time** - the estimated time left until you reach your destination.
- **Remaining distance** - the distance left until you reach your destination.
- **Current time**
- **Arrival time** - your estimated arrival time.
- **Speed**
- **Direction**
- **Show next street name** - the name of the next street on your trip.
- **Show current street name**
- **Show leeway to arrival time** - your RIDER shows how late or early you will be compared with the preferred arrival time that is set during the planning of a route.
- **Show max speed next to speed** - only available when speed (above) is also selected.
- **Show compass**
- **How should the status bar be displayed?**

Horizontal - If you choose this option, the status bar will be shown at the bottom of the Driving view.

Vertical - If you choose this option, the status bar will be shown at the right-hand side of the Driving view.

Note: *If the speed limit for the road you are on is available, it is shown next to your speed.*

If you drive faster than the speed limit, your speed is shown in red.

Compass preferences

This button may only be available if all menu options are shown. To show all menu options, tap **Show ALL menu options** in the Preferences menu.



Compass preferences

Tap this button to configure the compass. The following options are available:

- **None** - the compass is not shown.
- **One with arrow pointing north** - the arrow always points towards north and the direction you are moving is shown at the top of the compass.
- **One with arrow showing your heading** - the arrow always shows the direction you are moving.

If you select one of these options, you then need to select the features that are shown in the middle of the arrow:

- **Direction** - your direction is shown as a compass point, displayed in the center of the compass arrow.
- **Degrees** - your direction is shown as compass degrees, displayed in the center of the compass arrow.
- **Nothing**
- **One with arrow pointing to your destination** - the arrow always points towards your destination. The distance to your destination is displayed in the compass arrow.

Change map colors

This button may only be available if all menu options are shown. To show all menu options, tap **Show ALL menu options** in the Preferences menu.

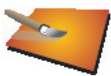

Change map colors

Tap this button to select the color schemes for day and night map colors.

You can also download more color schemes from TomTom Services.

Brightness preferences

This button may only be available if all menu options are shown. To show all menu options, tap **Show ALL menu options** in the Preferences menu.



Brightness preferences

Tap this button to set the brightness of the screen.

You can set the brightness separately for day map colors and for night map colors.

You can also set these options:

- **Turn brightness down when dark** - your RIDER uses a light sensor to detect the background light level. If this option is selected, as it gets darker, your RIDER reduces the brightness of the screen so that it is not distracting.
- **Switch to night view when dark** - your RIDER uses a light sensor to detect the background light level. If this option is selected, when it gets dark, your RIDER uses night colors for the Driving View.

You can set the map color scheme by tapping **Change map colors**.

Safety preferences



Safety preferences

Tap this button to set the following safety preferences:

- **Hide most menu options while driving**
- **Suggest driving breaks**
- **Show safety reminders**
- **Warn when near places of worship or schools**
- **Warn when driving faster than allowed**
- **Warn when driving faster than a set speed**
- **Warn not to leave the device in the car**

If you select one or more of the warnings, you will also be asked to select a sound to be played whenever a warning is displayed.

Select whether or not your TomTom RIDER should warn you about which side of the road you should be driving on.

Decide if you want the map display to be turned off in special circumstances and press **Done**.

What happens when I use the Turn off map display option?

When you turn off the map display, instead of seeing your position on a map in the Driving View, you will only see information about the next instruction.

Tap the button and select an option for when the map should be turned off. These are the options:

- **Always** - The map will not be shown and you will only see information about the next instruction and arrows showing direction.
- **Above a certain speed** - you set the speed at which point the map will be turned off. This option is useful for situations when the map might be distracting, such as when you are driving fast.
- **Never** - the map is never turned off.

Safety driving menu

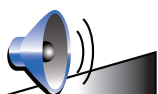

Safety driving menu

Tap this button to set the button shown in the bottom right-hand corner of the Safety Driving Menu.

By default, **Add favorite** is shown in this position. You can change this to, for example, show the trip statistics for the day, start a hands-free call to a specific number, or add a position to an Itinerary.

Quick menu preferences

This button may only be available if all menu options are shown. To show all menu options, tap **Show ALL menu options** in the Preferences menu.



Quick menu preferences

Tap this button to choose up to six buttons to be used in the Quick menu.

The Quick menu button enables easy access for your most commonly used buttons.

The buttons you assign for use with the Quick menu, are shown in the Driving View.

Instruction preferences

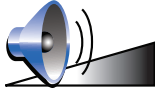

Instruction preferences

Tap this button to set the way your navigation device provides instructions such as directions and warnings.

Name preferences

This button may only be available if all menu options are shown. To show all menu options, tap **Show ALL menu options** in the Preferences menu.



Name preferences

Tap this button to set the information that is shown on the map in the Driving View. The following options are available:

- **Show house numbers before street names**
- **Show street names** - if you are using a computer voice for spoken instructions and have selected that street names should be read aloud, you do not need to select this option, since the street names will be read aloud even though this option is not selected.
- **Show next motorway / signpost** - when this option is selected, the next major road on your route is shown at the top of the screen in the Driving View.
- **Show current street name on map**

Set units

This button may only be available if all menu options are shown. To show all menu options, tap **Show ALL menu options** in the Preferences menu.

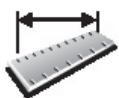

Set units

Tap this button to set the type of units that will be shown for the following:

- Distance
- Time
- Latitude and longitude
- Temperature
- Air pressure

Operate left-handed / Operate right-handed

This button may only be available if all menu options are shown. To show all menu options, tap **Show ALL menu options** in the Preferences menu.



Operate left-handed

Tap this button to move important buttons, for example, the **Done** and **Cancel** buttons as well as the zoom bar, to the left hand side of the screen. This makes it easier to tap the buttons with your left hand without blocking the screen.

To move the buttons back to the right hand side of the screen, tap **Operate right-handed**.

Keyboard preferences



Keyboard preferences

You use the keyboard to enter your destination or to find an item in a list, such as a POI.

Tap this button to select the size of the keys on the keyboard and the keyboard layout. You can select from two sizes:

- **Large keyboard**
- **Small keyboard**

Three keyboard layouts are available:

- **ABCD keyboard**
- **QWERTY keyboard**
- **AZERTY keyboard**

Note: *The keyboard does not include accents of any kind for any language so you don't have to worry about entering letters with accents. Simply type the letter without the accent and your RIDER will recognize the word.*

Planning preferences

This button may only be available if all menu options are shown. To show all menu options, tap **Show ALL menu options** in the Preferences menu.



Planning preferences

Tap this button to set the kind of route planned when you select a destination.

The following options are available:

- **Ask me every time I plan**
- **Always plan fastest routes**
- **Always plan shortest routes**
- **Always avoid freeways**
- **Always plan walking routes**
- **Always plan bicycle routes**
- **Always plan for limited speed**

Then answer the following question:

Do you want the route summary screen to close automatically after 10 seconds?

Toll road preferences

This button may only be available if all menu options are shown. To show all menu options, tap **Show ALL menu options** in the Preferences menu.



Toll road preferences

Tap this button to set how your RIDER handles toll roads if they are on the route to a destination you set. You can choose from the following options:

- **Ask me when there are toll roads on my route** - you are asked if you want to avoid a toll road whenever you plan a route.
- **Always avoid toll roads**
- **Never to avoid toll roads**

Set owner

This button may only be available if all menu options are shown. To show all menu options, tap **Show ALL menu options** in the Preferences menu.



Set owner

Tap this button to enter your name and address as the owner of your RIDER and to change or delete a 4-digit password for your RIDER.

Note: *You can only change or delete a 4-digit password on your TomTom RIDER.*

You can create a 4-digit password for your RIDER using TomTom HOME:

1. Connect your RIDER to your computer and turn on your RIDER and your computer.

TomTom HOME starts automatically.

2. From the Options menu in TomTom HOME, click My RIDER.
3. Click the ON/OFF button on the picture of your RIDER to start the application on your computer.
4. From the Main Menu, click **Change preferences**.
5. Click **Set Owner**. You can now set a 4-digit password for your RIDER.

You can only create a 4-digit password using TomTom HOME.

Set clock



Set clock

Tap this button to select the type of clock that is shown and set the time.

The easiest way to set the time is by tapping the **Sync** button. Your RIDER will then take the time from GPS information.

Note: *After using **Sync** to set the time, you may have to adjust the hours depending on your time zone. Your RIDER works out your time zone and always keeps the time correct using GPS information.*

*You can only use **Sync** if you have GPS reception, so you cannot set the clock in this way when you are indoors.*

Do not ask arrival time

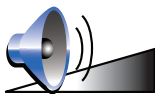

Do not ask arrival time

Tap this button to stop your navigation device asking the arrival time when you plan a trip.

Battery saving preferences

This button may only be available if all menu options are shown. To show all menu options, tap **Show ALL menu options** in the Preferences menu.



Battery saving preferences

Tap this button to configure your RIDER to conserve power when possible. The following options are available:

- **Never turn off screen**
- **Turn off screen between instructions**
- **Always turn off screen**

Then select whether or not you want to **Switch off when external power is lost**.

Start-up preferences

This button may only be available if all menu options are shown. To show all menu options, tap **Show ALL menu options** in the Preferences menu.



Start-up preferences

Tap this button to select how your RIDER will behave when you turn on the device. The following options are available:

- **Show the Driving View** - your RIDER starts and shows the Driving View.
- **Ask for a destination** - your RIDER starts with **Navigate to...** menu. You can enter a destination immediately.
- **Show the Main Menu** - your RIDER starts with the Main Menu.

Bluetooth preferences

This button may only be available if all menu options are shown. To show all menu options, tap **Show ALL menu options** in the Preferences menu.



Bluetooth preferences

Tap this button to disable or enable Bluetooth functionality on your RIDER.

Tap **Advanced** to set how the Bluetooth connection with your phone will be used.

You can select any of the following options:

- **Enable wireless data**
- **Enable hands-free calling**

In some places, such as hospitals and airplanes, you are required to turn Bluetooth off on all electronic devices.

Disable wireless data / Enable wireless data

This button may only be available if all menu options are shown. To show all menu options, tap **Show ALL menu options** in the Preferences menu.



Disable wireless data

Tap this button to block the reception of wireless data. You will still be connected to your mobile phone via Bluetooth and will still be able to receive and make hands-free calls. You will not be able to receive any data that uses a wireless data connection, such as TomTom Traffic.

To turn wireless data on again, tap **Enable wireless data**.

Send/Receive files

This button may only be available if all menu options are shown. To show all menu options, tap **Show ALL menu options** in the Preferences menu.



Send/Receive files

Tap this button to send or receive files, such as itineraries and voices, using your RIDER with other Bluetooth devices.

Connect to headset

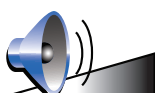

Connect to headset

Tap this button to setup and connect your headset to your navigation device.

Edit TomTom Services account

This button may only be available if all menu options are shown. To show all menu options, tap **Show ALL menu options** in the Preferences menu.



Edit TomTom account

Tap this button to log in to your TomTom account.

If you have more than one TomTom account or if several people are sharing the same TomTom RIDER, you can create another TomTom account using a different e-mail address.

Change language



Change language

Tap this button to change the language used for all the buttons and messages you see on your RIDER.

You can choose from a wide range of languages. When you change the language, you are also given the opportunity to change the voice.

Guided tours

This button may only be available if all menu options are shown. To show all menu options, tap **Show ALL menu options** in the Preferences menu.



Guided tours

Tap this button to show one of the Guided tours on how to use your TomTom RIDER.

Hidden buttons and features

When you first start using your TomTom RIDER, all the buttons are shown in the menu.

The buttons for the more advanced features can be hidden. This is a useful option because you are unlikely to use certain features very often.



Show fewer menu options

Tap this button in the Preferences menu, to reduce the number of buttons that are shown.

You might want to do this so that only frequently used buttons are shown.

When you need to use the buttons that are hidden, you can press **Show ALL menu options** in the Preferences menu to show all buttons.



Show ALL menu options

Tap this button in the Preferences menu, to show all the buttons available on your TomTom RIDER.

Hide tips / Show tips

This button may only be available if all menu options are shown. To show all menu options, tap **Show ALL menu options** in the Preferences menu.



Hide tips

Tap this button to stop your RIDER from showing tips.

To turn tips on again, tap **Show tips**.

Reset factory settings

This button may only be available if all menu options are shown. To show all menu options, tap **Show ALL menu options** in the Preferences menu.



Reset factory settings

Tap this button to restore the factory settings to your TomTom RIDER.

All your settings, including Favorites, your Home location, warnings for POIs and any Itineraries you have created, as well as recent destinations and recent calls and callers, will be deleted.

13. TomTom Traffic

TomTom Traffic is a TomTom Service for receiving up-to-date traffic information. TomTom Traffic requires a Bluetooth-enabled mobile phone and a wireless data connection (GPRS, EDGE, UMTS, CDMA).

TomTom Traffic is a TomTom Service for receiving up-to-date traffic information. TomTom Traffic requires a wireless data connection (GPRS, EDGE, UMTS, CDMA).

TomTom Traffic uses the most up-to-date information from the best local sources. For more information about subscribing see tomtom.com/services

Setting up TomTom Traffic

To use TomTom Traffic, you need to establish a connection between your mobile phone and your TomTom device. If you have not already done so, tap **Mobile phone** in the **Main Menu** to establish this connection and then do the following:

1. Tap TomTom **Traffic** in the Main Menu.
2. Tap **Enable Traffic**.

Note: TomTom Traffic retrieves traffic information using a wireless data connection on your mobile phone. You must establish a Bluetooth connection between your phone and your device and you must also have a wireless data subscription with your mobile network operator.

3. Enter your username and password.

The Traffic sidebar is shown on the right-hand side of the Driving View and your device retrieves the latest traffic information from TomTom.

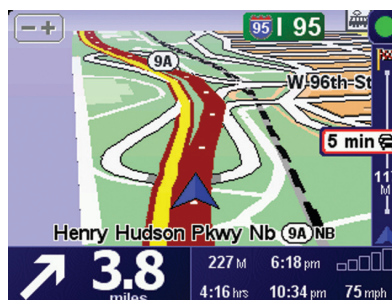

The following symbols are shown at the top of the Traffic sidebar:



Your device is busy retrieving traffic information.



Traffic information is up to date.



Traffic information has not been updated for at least 15 minutes.



Traffic information has not been updated for at least 30 minutes.



Traffic information has not been updated for at least 45 minutes.



Traffic information has not been updated for at least one hour.



No connection is available between your TomTom device and your mobile.

Tip: Providing you have a connection between your device and mobile phone, You can retrieve the latest traffic information straight away by tapping the **Update traffic info** button in the Traffic menu.

Using TomTom Traffic

If you have a route planned, the traffic sidebar warns you about any traffic incidents on your route.

To find the quickest route to your destination, do the following:

1. Tap the Traffic sidebar.

Tip: If you have trouble tapping the Traffic sidebar and the Main Menu is being displayed instead of the traffic menu, try tapping your finger half on the Traffic sidebar and half off the screen.

2. Tap **Minimize traffic delays**.

Your device looks for the quickest route to your destination.

It is possible that the new route may also include traffic delays, or may even be the same route as before. You can re-plan the route to avoid all delays, but this new route will take longer than the quickest route already shown.

3. Tap **Done**.

Retrieving traffic info...

With TomTom Traffic, there are two ways to update the traffic information:

- Tap **Update traffic info** in the Traffic menu.
- Set Traffic to be updated automatically at regular intervals.

To do this, tap **Change Traffic preferences** in the Traffic menu. Select **Automatically update traffic info while on route**, then tap **Done**.

You are then asked if you want to limit how often Traffic is updated.

If you choose not to limit how often Traffic is updated, then TomTom will send updated traffic information to your RIDER as soon as it is available.

If you choose to limit how often Traffic is updated, you are asked to set a time.

TomTom saves this time limit and sends new traffic information at the interval you set. If there is no new traffic information, then TomTom will not send any information to your RIDER. This saves you money by not using your wireless data connection when there is no new information.

Using traffic information

Having up-to-date traffic information can help you to reduce your trip time.

Whenever you plan a route, the latest traffic updated you received from TomTom is taken into account by your RIDER when it plans the route.

Your RIDER can also recalculate your route if the traffic situation changes after you start a trip:

1. Tap **Change Traffic preferences** in the Traffic menu.
2. Select **Automatically optimize route after every update**.

After your RIDER gets new traffic information, it will automatically optimise your route.

Note: *The best route may be the same as the route originally planned.*

14. Introducing TomTom HOME

TomTom HOME is a free application for your computer that helps you manage the contents of your TomTom device. Connect to HOME frequently to get the latest updates for your device.

You can, for example, do the following:

- Manage maps, voices, POIs and more.
- Buy TomTom services and manage your subscriptions.
- Update your TomTom with the latest software and services automatically.
- Make and restore backups.
- Read the full version of the user manual.

Tip: To get the most from HOME, we recommend using a broadband internet connection.

Use TomTom HOME to make a backup of your device.

Installing TomTom HOME

To install TomTom HOME on your computer, do the following:

1. Connect your computer to the internet.
2. Connect your device to your computer using the USB cable, then switch your device on.

HOME starts to install.

Note: If HOME does not install automatically, you can also download it from tomtom.com/home

You can also install TomTom HOME from the CD supplied.

Once installed, TomTom HOME starts automatically when you connect your device to your computer and turn it on.

15. How Does Navigation Work?

Global Positioning System (GPS)

In order to navigate you to your destination, your TomTom RIDER must know where you are now. To find your current position, your TomTom RIDER uses the Global Positioning System (GPS). GPS is available for free and without subscription.

GPS uses satellites to transmit signals to GPS receivers. Your TomTom RIDER has a built-in GPS receiver. Using the GPS signal, your TomTom RIDER can work out where you are and how fast you are going. GPS signals work in all weather, anywhere in the world.

Note: *Your TomTom RIDER does not transmit your position, so others cannot use it to track you while you are driving. You can, however, send your position to TomTom Buddies. For more information, visit www.tomtom.com/plus*

Maps

Once your RIDER knows where you are and you have told it where you want to go, it uses the digital map on the memory card to work out the best route to your destination.

16. TomTom limited warranty

WARRANTOR

Non-U.S. and non-Canadian purchases: If you have made your purchase outside the United States and Canada, this Limited Warranty is granted by and this Limitation of Liability is stipulated for the benefit of TomTom International B.V., Rembrandtplein 35, 1017 CT Amsterdam (The Netherlands).

WHAT THIS WARRANTY COVERS

1) TomTom International B.V. ("TomTom") warrants to you that the Hardware will be free from defects in workmanship and materials under normal use ("Defects") for a period of one (1) year from the date that the Hardware was first purchased by you ("Warranty Period"). During the Warranty Period the Hardware will be repaired or replaced at TomTom's choice ("Limited Warranty") without charge to you for either parts or labour. This Limited Warranty covers the replacement of the Hardware only. If the Hardware is repaired after the Warranty Period has expired, the Warranty Period for the repair will expire six (6) months after the date of repair.

WHAT THIS WARRANTY DOES NOT COVER

2) The Limited Warranty does not apply to normal wear and tear, does not apply when the Hardware is opened or repaired by someone not authorized by TomTom and does not cover repair or replacement of any Hardware or part thereof damaged by: misuse, moisture, liquids, proximity or exposure to heat and accident, abuse, non-compliance with the instructions supplied with the Hardware, neglect or misapplication. The Limited Warranty does not cover physical damage to the surface of the Hardware. This Limited Warranty does not cover any software that may accompany or be installed on the Hardware. The Limited Warranty does not cover the installation, removal or maintenance of the Hardware or any costs related herewith.

HOW TO MAKE A WARRANTY CLAIM

3) In order to make a claim of a Defect, you must contact TomTom by email during the Warranty Period via www.tomtom.com to explain the Defect and to obtain an RMA number (Return Materials Authorization) if necessary. You must return the Hardware during the Warranty Period, along with an explanation of the Defect, to the address provided to you by TomTom. If a defect arises and a valid claim under this Limited Warranty is received by TomTom after the first one hundred and eighty (180) days of the Warranty Period, TomTom is entitled to charge you for any reasonable shipping and handling costs made in connection with the repair or replacement of the Hardware. You must comply with any other return procedures stipulated by TomTom, if any.

YOUR LEGAL RIGHTS

4) Some countries may not allow the exclusion or limitation of damages. If any part of this Limited Warranty is held to be invalid or unenforceable, the remainder of the Limited Warranty shall nonetheless remain in full force and effect.

5) This Limited Warranty is the only express warranty made to you and is provided in lieu of any other express warranties or similar obligations (if any) created by any advertising, documentation, packaging, or other communications.

6) Except for the Limited Warranty and to the maximum extent permitted by applicable law, TomTom and its suppliers provide the Hardware "AS IS AND WITH ALL FAULTS", and hereby disclaim all other warranties and conditions, whether express, implied or statutory, including, but not limited to, any (if any) implied warranties, duties or conditions of satisfactory quality, of fitness for a particular purpose, of reliability or availability, of accuracy or completeness of responses, of results, of workmanlike effort, of lack of viruses, and of reasonable care and skill, all with regard to the Hardware, and the provision of or failure to provide support or other services, information, software, and related content through the Hardware or otherwise arising out of the use of the Hardware. Also, there is no warranty or condition of quiet enjoyment, quiet possession, or non-infringement with regard to the Hardware. This exclusion does not apply to (i) any implied condition as to title and (ii) any implied warranty as to conformity with description.

7) This Limited Warranty does not affect any legal rights under applicable national legislation governing the sale of consumer goods.

8) This Limited Warranty cannot be transferred to any other person.

LIMITATION OF LIABILITY

9) Neither TomTom nor its suppliers shall be liable to you or to any third party for any damages either direct, indirect, incidental, consequential or otherwise (including in each case, but not limited to, damages for the inability to use the equipment or access data, loss of data, loss of business, loss of profits, business interruption or the like) arising out of the use of or inability to use the Hardware even if TomTom has been advised of the possibility of such damages.

10) Notwithstanding any damages that you might incur for any reason whatsoever (including, without limitation, all damages referenced herein and all direct or general damages in contract or anything else), the entire liability of TomTom and any of its suppliers shall be limited to the amount actually paid by you for the Hardware.

11) TomTom shall not be liable for (i) any fraud on the part of its employees and/or agents; or (ii) any fraudulent misrepresentation on the part of its employees and/or agents.

12) Notwithstanding the above, neither party's liability for death or personal injury resulting from its own negligence shall be limited.

TomTom Limited Warranty

WARRANTOR

U.S. and Canadian Purchases: If you have made your purchase in the United States or Canada, this Limited Warranty is granted by and this Limitation of Liability is stipulated for the benefit of TomTom Inc., 150 Baker Avenue Extension, Concord Massachusetts 01742 (United States of America).

WHAT THIS WARRANTY COVERS

1) TomTom Inc. ("TomTom") warrants to the original purchaser ("you") of the hardware with which this Limited Warranty is included ("Hardware") that the Hardware will be free from defects in workmanship and materials under normal use ("Defects") for a period of one (1) year from the date that the Hardware was first purchased by you ("Warranty Period"). During the Warranty Period the Hardware will be repaired or replaced at TomTom's choice ("Limited Warranty") without charge to you for either parts or labour. This Limited Warranty covers the replacement of the Hardware only. If the Hardware is repaired after the Warranty Period has expired, the Warranty Period for the repair will expire six (6) months after the date of repair.

WHAT THIS WARRANTY DOES NOT COVER

2) The Limited Warranty does not apply to normal wear and tear, does not apply when the Hardware is opened or repaired by someone not authorized by TomTom and does not cover repair or replacement of any Hardware or part thereof damaged by: misuse, moisture, liquids, proximity or exposure to heat and accident, abuse, non-compliance with the instructions supplied with the Hardware, neglect or misapplication. The Limited Warranty does not cover physical damage to the surface of the Hardware. This Limited Warranty does not cover any software that may accompany or be installed on the Hardware. The Limited Warranty does not cover the installation, removal or maintenance of the Hardware or any costs related herewith.

HOW TO MAKE A WARRANTY CLAIM

3) In order to make a claim of a Defect, you must contact TomTom during the Warranty Period at: 1-978-287-9555 or per email via www.tomtom.com to explain the Defect and to obtain an RMA number (Return Materials Authorization) if necessary. You must return the Hardware during the Warranty Period, along with an explanation of the Defect, to the address provided to you by TomTom. If a defect arises and a valid claim under this Limited Warranty is received by TomTom after the first one hundred and eighty (180) days of the Warranty Period, TomTom is entitled to charge you for any reasonable shipping and handling costs made in connection with the repair or replacement of the Hardware. You must comply with any other return procedures stipulated by TomTom, if any.

YOUR LEGAL RIGHTS

4) This Limited Warranty gives you specific legal rights, and you may also have other rights which vary from state to state and jurisdiction to jurisdiction.

5) If any part of this Limited Warranty is held to be invalid or unenforceable, the remainder of the Limited Warranty shall nonetheless remain in full force and effect.

6) This Limited Warranty is the only express warranty made to you and is provided in lieu of any other express warranties or similar obligations (if any) created by any advertising, documentation, packaging, or other communications.

7) Except for the Limited Warranty and to the maximum extent permitted by applicable law, TomTom and its suppliers provide the Hardware "AS IS AND WITH ALL FAULTS", and hereby disclaim all other warranties and conditions, whether express, implied or statutory, including, but not limited to, any (if any) implied warranties, duties or conditions of: merchantability, non-infringement, quiet enjoyment, system integration, satisfactory quality, fitness for a particular purpose, reliability or availability, accuracy or completeness of responses, results, workmanlike effort, lack of viruses, and reasonable care and skill, all with regard to the Hardware, and the provision of or failure to provide support or other services, information, software, and related content through the Hardware or otherwise arising out of the use of the Hardware. This exclusion does not apply to (i) any implied condition as to title and (ii) any implied warranty as to conformity with description. If applicable law requires

any implied warranties with respect to the Hardware, all such warranties are limited in duration to ninety (90) days. Some states and/or jurisdictions do not allow limitations on how long an implied warranty lasts, so the above may not apply to you.

8) This Limited Warranty cannot be transferred to any other person.

LIMITATION OF LIABILITY

9) Neither TomTom nor its suppliers shall be liable to you or to any third party for any indirect, incidental, consequential, special or exemplary damages (including in each case, but not limited to, damages for the inability to use the equipment or access data, loss of data, loss of business, loss of profits, business interruption or the like) arising out of the use of or inability to use the Hardware even if TomTom has been advised of the possibility of such damages.

10) Notwithstanding any damages that you might incur for any reason whatsoever (including, without limitation, all damages referenced herein and all direct or general damages in contract or anything else), the entire liability of TomTom and any of its suppliers shall be limited to the amount actually paid by you for the Hardware.

11) Notwithstanding the above, neither party's liability for death or personal injury resulting from its own negligence shall be limited.

12) Some states and/or jurisdictions do not allow the exclusion or limitation of incidental or consequential damages, so the above limitations or exclusions may not apply to you.

17. Addendum

Important Safety Notices and Warnings

Global Positioning System

The Global Positioning System (GPS) is a satellite-based system that provides location and timing information around the globe. GPS is operated and controlled under the sole responsibility of the Government of the United States of America which is responsible for its availability and accuracy. Any changes in GPS availability and accuracy, or in environmental conditions, may impact the operation of your TomTom device. TomTom does not accept any liability for the availability and accuracy of GPS.

Use with Care

Use of a TomTom device for navigation still means that you need to drive with due care and attention.

Taking care of your TomTom device

Do not leave your TomTom device or TomTom accessories on view when you leave your car. They may become an easy target for thieves.

You can set a password for your device which must be entered every time you start your device.

We recommend that you use the safety preferences on your TomTom device, where available. The safety preferences are available in the Preferences menu.

Take care of your TomTom device and clean it correctly.

- Use a soft cloth to wipe the screen of your device; do not use any liquid cleaners.
- If your device gets wet, dry it with a soft cloth.
- Do not open the casing of your device under any circumstances. Doing so may be dangerous and will invalidate your warranty.
- Do not use the memory card (SD card) with any device other than a TomTom device. Other devices may damage the memory card.
- Do not expose your device to high or low temperatures, which can cause permanent damage. For example, don't leave it in the car on hot summer days or during cold winter nights.

Aircraft and Hospitals

Use of devices with an antenna is prohibited on most aircraft, in many hospitals and in many other locations. A TomTom device must not be used in these environments.

Battery

This product uses a Lithium-Polymer battery. Do not use it in a humid, wet and/or corrosive environment. Do not put, store or leave your product in or near a heat source, in a high temperature location, in strong direct sunlight, in a microwave oven or in a pressurized container, and do not expose it to temperatures over 60 C (140 F). Failure to follow these guidelines may cause the Lithium-Polymer battery to leak acid, become hot, explode or ignite and cause injury and/or damage. Do not pierce, open or disassemble the battery. If the battery leaks and you come into contact with the leaked fluids, rinse thoroughly with water and seek medical attention immediately. For safety reasons, and to prolong the lifetime of the battery, charging will not occur at low (below 0 C/32 F) or high (over 45 C/113 F) temperatures.

Temperatures: Standard operation: -10 C (14 F) to +55 C (131 F); short period storage: -20 C (-4 F) to + 60 C (140 F); long period storage: -20 C (-4 F) to +25 C (77 F).



THE LITHIUM-POLYMER BATTERY CONTAINED IN THE PRODUCT MUST BE RECYCLED OR DISPOSED OF PROPERLY. USE YOUR TomTom ONLY WITH THE SUPPLIED DC POWER LEAD (CAR CHARGER/BATTERY CABLE) AND AC ADAPTER (HOME CHARGER) FOR BATTERY CHARGING.

To recycle your TomTom unit please see your local approved TomTom service center.

Mounting TomTom RIDER

Extreme care must be taken when mounting TomTom RIDER on a motorcycle. Read the description in the Quick Start Guide carefully before mounting TomTom RIDER on your motorcycle. TomTom RIDER shall be mounted in compliance with the relevant legislation and the vehicle manufacturer's rules. Failure to mount TomTom RIDER correctly could result in damage to your vehicle and serious injury to the vehicle rider and other road users. TomTom RIDER is mounted on your motorcycle at your own risk.

Battery cable

The power cable shall be routed to avoid sharp bends, abrasion, overheating, exhaust gases and battery acids and other potential hazards. It must not be strained nor distorted by e.g. excessive tightening of cable ties. Ensure that all connections are mechanically and electrically safe and secure. Keep away from heat sources and vehicle controls. It must not hinder the operation of safety equipment nor interfere with the driver's ability to control the vehicle.

SPECIAL NOTE REGARDING DRIVING IN CALIFORNIA AND MINNESOTA

California Vehicle Code Section 26708 (a) (1) provides that "No persons shall drive any motor vehicle with an object or material placed, displayed, installed, affixed or applied upon the windshield or side or rear windows." Drivers in California should not use a suction mount on their windshield, side or rear windows.

Note: this section of the California Vehicle Code applies to anyone driving in California, not just California residents.

Minnesota State Legislature Statutes Section 169.71, subdivision 1, section 2 provides that "A person shall not drive or operate with any objects suspended between the driver and the windshield other than sun visors and rearview mirrors and electronic toll collection devices."

Note: this Minnesota Statute applies to anyone driving in Minnesota, not just Minnesota residents.

TomTom Inc. bears no responsibility for any fines, penalties or damage that may be incurred by disregarding this notice. While driving in any state with windshield mounting restrictions, TomTom recommends the use of the supplied Adhesive Mounting Disk or its Alternative Mounting Kit, which includes multiple options for mounting TomTom devices on the dashboard and using the air vents. See www.tomtom.com for more information about this mounting option.

FCC Information for the User



This product contains a transmitter which must not be co-located or simultaneously operated in conjunction with any other transmitter.

Exposure to Radio Frequency Radiation

This device complies with FCC radiation exposure limits set forth for an uncontrolled environment. In order to avoid the possibility of exceeding the FCC radio frequency exposure limits, human proximity to the antenna shall not be less than 20cm (8 inches) during normal operation.

Radio and Television Interference

This equipment radiates radio frequency energy and if not used properly - that is, in strict accordance with the instructions in this manual - may cause interference to radio communications and television reception.

This device has been tested and found to comply with the limits for a Class B digital device, pursuant to Part 15 of the FCC Rules. These limits are designed to provide reasonable protection against harmful interference in a residential installation. This equipment generates, uses and can radiated radio frequency energy and, if not installed and used in accordance with the instructions, may cause harmful interference to radio communications. However, there is no guarantee that interference will not occur in a particular installation. If this equipment does cause harmful interference to radio or television reception, which can be determined by turning the equipment off and on, the user is encouraged to try to correct the interference by one or more of the following measures:

- Reorient or relocate the receiving antenna.
- Increase the separation distance between the equipment and the receiver.
- Connect the equipment into an outlet on a circuit different from that to which the receiver is connected.
- Consult an experienced radio/TV technician for help.

Changes or modifications not expressly approved by the party responsible for compliance could void the user's authority to operate the equipment.

Important

This equipment was tested for FCC compliance under conditions that included the use of shielded cables and connectors between it and the peripherals. It is important that you use shielded cable and connectors to reduce the possibility of causing radio and television interference. Shielded cables, suitable for the product range, can be obtained from an authorised dealer. If the user modifies the equipment or its peripherals in any way, and these modifications are not approved by TomTom, the FCC may withdraw the user's right to operate the equipment. For customers in the USA, the following booklet prepared by the Federal Communications Commission may be of help: "How to Identify and Resolve Radio-TV Interference Problems". This booklet is available from the US Government Printing Office, Washington, DC 20402. Stock No 004-000-00345-4.

FCC Declaration of Conformity

Tested to Comply with FCC Standards for Home or Office Use

This device complies with part 15 of the FCC Rules. Operation is subject to the following two conditions:

1. This device may not cause harmful interference.
2. This device must accept any interference received, including interference that may cause undesired operation.

Responsible party in North America

TomTom, Inc., 150 Baker Avenue Extension, Concord, MA 01742

Tel: 866 486-6866 option 1 (1-866-4-TomTom)

Emissions information for Canada

This Class B digital apparatus complies with Canadian ICES-003. Cet appareil numérique de la classe B est conforme à la norme NMB-003 du Canada.

Operation is subject to the following two conditions: (1) this device may not cause harmful interference and (2) this device must accept any interference, including interference that may cause undesired operation of the device.

This category II radiocommunication device complies with Industry Canada Standard RSS-310.

Ce dispositif de radiocommunication de catégorie II respecte la norme CNR-310 d'Industrie Canada.

CE Marking



This equipment complies with the requirements for CE marking when used in a residential, commercial, vehicular or light industrial environment.

R&TTE Directive

Hereby, TomTom declares that this personal navigation device is in compliance with the essential requirements and other relevant provisions of the EU Directive 1999/5/EC. The declaration of conformity can be found here: www.tomtom.com/lib/doc/CE_DoC_RIDER-3.pdf

Hiermit erklärt TomTom, dass dieses persönliche Navigationsgerät die grundlegenden Anforderungen und andere relevante Bestimmungen der EU-Richtlinie 1999/5/EC erfüllt. Die Konformitätserklärung finden Sie hier: www.tomtom.com/lib/doc/CE_DoC_RIDER-3.pdf

Par la présente, TomTom déclare que cet appareil de navigation personnelle est conforme aux principales exigences et autres dispositions applicables de la directive UE 1999/5/CE. La déclaration de conformité peut être consultée à l'adresse suivante : www.tomtom.com/lib/doc/CE_DoC_RIDER-3.pdf

TomTom verklaart hierbij dat dit persoonlijke navigatiesysteem voldoet aan alle essentiële vereisten en overige relevante bepalingen in de EU-richtlijn 1999/5/EC. De conformiteitsverklaring vindt u hier: www.tomtom.com/lib/doc/CE_DoC_RIDER-3.pdf

Con la presente, TomTom dichiara che questo dispositivo di navigazione personale è conforme ai requisiti essenziali e alle clausole pertinenti della Direttiva 1999/5/EC dell'UE. La dichiarazione di conformità è consultabile all'indirizzo: www.tomtom.com/lib/doc/CE_DoC_RIDER-3.pdf

Por la presente, TomTom declara que este dispositivo de navegación personal se ha fabricado en conformidad con los requisitos esenciales y otras provisiones relevantes de la Directiva de la UE 1999/5/EC. La declaración de

conformidad puede consultarse en: www.tomtom.com/lib/doc/CE_DoC_RIDER-3.pdf

TomTom erklærer herved, at denne personlige navigationsenhed er i overensstemmelse med de væsentligste krav og andre relevante bestemmelser i Europa-Parlamentets og Rådets direktiv 1999/5/EF. Overensstemmelseserklæringen findes her: www.tomtom.com/lib/doc/CE_DoC_RIDER-3.pdf

Härmed förklarar TomTom att denna personliga navigationsenhet uppfyller de grundläggande kraven och andra relevanta föreskrifter i EU-direktiv 1999/5/EG. Konformitetsdeklarationen finns här: www.tomtom.com/lib/doc/CE_DoC_RIDER-3.pdf

TomTom täten vakuuttaa, että tämä henkilökohtainen navigointilaitte täyttää EU-direktiivin 1999/5/EY olennaiset vaatimukset ja sen muut asiaankuuluvat määräykset. Vaatimustenmukaisuusvakuutus löytyy täältä: www.tomtom.com/lib/doc/CE_DoC_RIDER-3.pdf

A TomTom declara por este meio que este equipamento de navegação pessoal está em conformidade com os requisitos fundamentais e outras cláusulas relevantes da Directiva da UE 1999/5/CE. A declaração de conformidade (em inglês) está disponível em: www.tomtom.com/lib/doc/CE_DoC_RIDER-3.pdf

Společnost TomTom tímto prohlašuje, že toto osobní navigační zařízení splňuje všechny nezbytné náležitosti a další relevantní ustanovení Směrnice EU 99/5/ES. Prohlášení o shodě naleznete zde: www.tomtom.com/lib/doc/CE_DoC_RIDER-3.pdf

Spoločnosť TomTom vyhlasuje, že toto osobné navigačné zariadenie vyhovuje základným požiadavkám a ďalším základným predpisom smernice EÚ 1999/5/EC. Prehlásenie o zhode nájdete na: www.tomtom.com/lib/doc/CE_DoC_RIDER-3.pdf

A TomTom ezennel kijelenti, hogy ez a személyi navigációs eszköz megfelel az 1999/5/EC EU irányelv alapvető követelményeinek és egyéb rá vonatkozó rendelkezéseinek. A megfelelőségi nyilatkozat a következő helyen található: www.tomtom.com/lib/doc/CE_DoC_RIDER-3.pdf

Firma TomTom oświadcza, że niniejsze, osobiste urządzenie nawigacyjne jest zgodne z najważniejszymi wymaganiami i innymi istotnymi postanowieniami Dyrektywy 1999/5/WE. Deklaracja zgodności znajduje się tutaj: www.tomtom.com/lib/doc/CE_DoC_RIDER-3.pdf

TomTom kinnitab käesolevaga, et see personaalne navigeerimisseade on kooskõlas EL direktiivi 1999/5/EÜ oluliste nõuete ja sätetega. Vastavusdeklaratsioon on aadressil: www.tomtom.com/lib/doc/CE_DoC_RIDER-3.pdf

TomTom nurodo, kad šis asmeninis navigavimo įrenginys atitinka pagrindinius ir kitus reikiamus ES direktyvos 1999/5/EC reikalavimus. Patvirtinimo deklaraciją rasite: www.tomtom.com/lib/doc/CE_DoC_RIDER-3.pdf

Ar šo TomTom paziņo, ka šī personālā navigācijas ierīce atbilst ES direktīvas 1999/5/EK būtiskajām prasībām un citiem svarīgajiem nosacījumiem. Atbilstības paziņojumu var lasīt šeit: www.tomtom.com/lib/doc/CE_DoC_RIDER-3.pdf

C-tick



This product displays the C-tick to show it complies with relevant Australian and New Zealand regulations.

Warning for Australia

The user needs to switch off the device when exposed to areas with potentially explosive atmospheres such as petrol stations, chemical storage depots and blasting operations.

Responsible party in Australia

TomTom Australia, Building 1, Suite 3, Level 3 , 3 Richardson Place, North Ryde NSW 2113, Australia

Tel: +612 8875 1700

This Document

Great care was taken in preparing this manual. Constant product development may mean that some information is not entirely up-to-date. The information in this document is subject to change without notice.

TomTom shall not be liable for technical or editorial errors or omissions contained herein; nor for incidental or consequential damages resulting from the performance or use of this material. This document contains information protected by copyright. No part of this document may be photocopied or reproduced in any form without prior written consent from TomTom International B.V.

Part numbers

TomTom RIDER: 4K00.100

18. Copyright notices

© 2008 TomTom International BV, The Netherlands. TomTom™ and the "two hands" logo are among the trademarks, applications or registered trademarks owned by TomTom International B.V. Our limited warranty and end user license agreement for embedded software apply to this product; you can review both at www.tomtom.com/legal

© 2008 TomTom International BV, Niederlande. TomTom™ und das Logo mit den »zwei Händen« gehören zu den Warenzeichen, Anwendungen oder registrierten Markenzeichen von TomTom International B.V. Für dieses Produkt gelten unsere eingeschränkte Garantie und unsere Endnutzerlizenzvereinbarung für integrierte Software, die Sie beide auf www.tomtom.com/legal einsehen und nachlesen können.

© 2008 TomTom International BV, The Netherlands. TomTom™ et le logo TomTom ("deux mains") comptent parmi les marques commerciales, les applications ou les marques déposées de TomTom International B.V. L'utilisation de ce produit est régie par notre garantie limitée et le contrat de licence utilisateur final relatif aux logiciels embarqués ; vous pouvez consulter ces deux documents à l'adresse suivante : www.tomtom.com/legal

© 2008 TomTom International BV, Nederland. TomTom™ en het "twee-handenlogo" maken onderdeel uit van de handelsmerken, applicaties of geregistreerde handelsmerken in eigendom van TomTom International B.V. Op dit product zijn onze beperkte garantie en licentieovereenkomst voor de eindgebruiker van toepassing; beide zijn te vinden op www.tomtom.com/legal

© 2008 TomTom International BV, The Netherlands. TomTom™ e il logo delle "due mani" fanno parte dei marchi, delle applicazioni e dei marchi registrati di proprietà di TomTom International B.V. La nostra garanzia limitata e il contratto di licenza per l'utente finale vengono applicati a questo prodotto, è possibile consultarli entrambi all'indirizzo www.tomtom.com/legal

© 2008 TomTom International BV, Países Bajos. TomTom™ y el logotipo "dos manos" son marcas comerciales, aplicaciones o marcas registradas de TomTom International B.V. Nuestra garantía limitada y nuestro acuerdo de licencia de usuario final para el software integrado son de aplicación para este producto; puede consultar ambos en www.tomtom.com/legal

© 2008 TomTom International BV, Países Baixos. TomTom™ e o logótipo das "duas mãos" fazem parte das marcas comerciais, aplicações ou marcas

comerciais registadas cuja proprietária é a TomTom International B.V. A nossa garantia limitada e contrato de licença de utilizador final relativas ao software incorporado dizem respeito a este produto; pode consultar ambos em www.tomtom.com/legal

© 2008 TomTom International BV, Holland. TomTom™ og logoet med "de to hænder" er blandt de varemærker, produkter og registrerede varemærker, der tilhører TomTom International B.V. Vores begrænsede garanti og slutbrugerlicensaf tale for indlejret software gælder for dette produkt; begge dokumenter findes på www.tomtom.com/legal

© 2008 TomTom International BV, Nederländerna. TomTom™ och logotypen "två händer" tillhör de varumärken, programvaror eller registrerade varumärken som ägs av TomTom International B.V. Vår begränsade garanti och vårt slutanvändarlicensavtal för inbyggd programvara kan gälla för denna produkt. Du kan läsa dem båda på www.tomtom.com/legal

2008 TomTom™ ja "two hands" -logo ovat eräitä TomTom International B.V.:n omistamia tavaramerkkejä, sovelluksia tai rekisteröityjä tavaramerkkejä. Rajoitettu takuumme ja loppukäyttäjän käyttösopimuksemme sulautetuille ohjelmistoille koskevat tätä tuotetta; voit tarkastaa molemmat verkkosivuiltamme www.tomtom.com/legal

© 2008 TomTom International BV, Nederland. TomTom™ og "de to hendene"-logoen er blant de varemerker, programvarer og registrerte varemerker som eies av TomTom International B.V. Vår begrensede garanti og lisensavtale med sluttbruker for integrert programvare gjelder dette produktet. Du kan lese om begge på www.tomtom.com/legal

Data Source

© 2008 Tele Atlas N.V. Based upon:

Topografische ondergrond Copyright © dienst voor het kadaster en de openbare registers, Apeldoorn 2008.

© Ordnance Survey of Northern Ireland.

© IGN France.

© Swisstopo.

© BEV, GZ 1368/2008.

© Geonext/DeAgostini.

© Norwegian Mapping Authority, Public Roads Administration /

© Mapsolutions. © DAV.

This product includes mapping data licensed from Ordnance Survey with the permission of the Controller of Her Majesty's Stationery Office. © Crown copyright and/or database right 2008. All rights reserved. Licence number 100026920.

Data Source

© 1984 – 2008 Tele Atlas North America. Inc. All rights reserved.

Canadian Data © DMTI Spatial. Portions of Canadian map data are reproduced under license from Her Majesty the Queen in Right of Canada with permission from Natural Resource Canada. Point of Interest data by Info USA. Copyright 2008.

Data Source

Whereis® map data is © 2008 Telstra® Corporation Limited and its licensors, Whereis® is a registered trademark of Telstra® Corporation Limited, used under license.

Some images are taken from NASA's Earth Observatory.

The purpose of NASA's Earth Observatory is to provide a freely-accessible publication on the Internet where the public can obtain new satellite imagery and scientific information about our home planet.

*The focus is on Earth's climate and environmental change:
earthobservatory.nasa.gov/*

*Text to Speech technology, © 2008 Loquendo TTS. All rights reserved.
Loquendo is a registered trademark. www.loquendo.com*
