

K9A2 Platinum Series

MS-7376 (v1.X) Mainboard

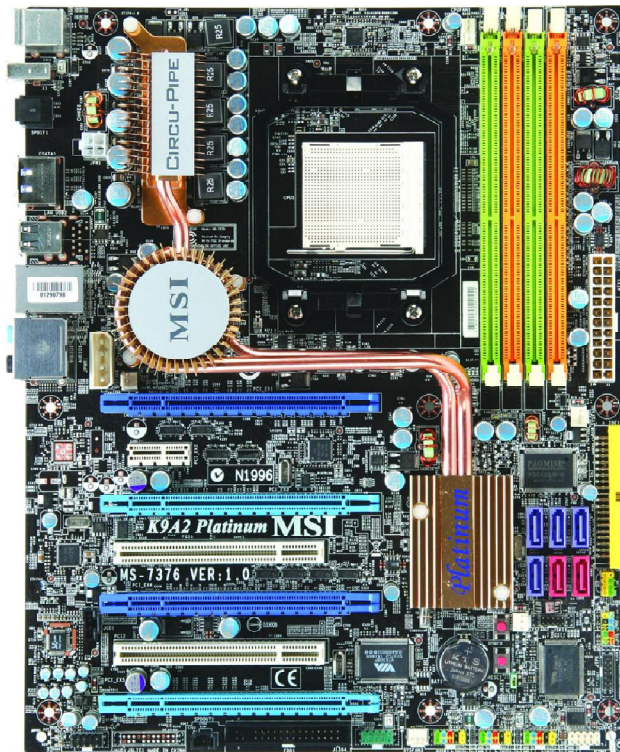

G52-73761X1

Copyright Notice

The material in this document is the intellectual property of **MICRO-STAR INTERNATIONAL**. We take every care in the preparation of this document, but no guarantee is given as to the correctness of its contents. Our products are under continual improvement and we reserve the right to make changes without notice.

Trademarks

All trademarks are the properties of their respective owners.

NVIDIA, the NVIDIA logo, DualNet, and nForce are registered trademarks or trademarks of NVIDIA Corporation in the United States and/or other countries.

AMD, Athlon™, Athlon™ XP, Thoroughbred™, and Duron™ are registered trademarks of AMD Corporation.

Intel® and Pentium® are registered trademarks of Intel Corporation.

PS/2 and OS®/2 are registered trademarks of International Business Machines Corporation.

Windows® 95/98/2000/NT/XP are registered trademarks of Microsoft Corporation.

Netware® is a registered trademark of Novell, Inc.

Award® is a registered trademark of Phoenix Technologies Ltd.

AMI® is a registered trademark of American Megatrends Inc.

Revision History

Revision	Revision History	Date
V1.0	First for PCB 1.X	December 2007

Technical Support

If a problem arises with your system and no solution can be obtained from the user's manual, please contact your place of purchase or local distributor. Alternatively, please try the following help resources for further guidance.

- ① Visit the MSI website for FAQ, technical guide, BIOS updates, driver updates, and other information: <http://global.msi.com.tw/index.php?func=faqIndex>
- ① Contact our technical staff at: <http://support.msi.com.tw/>

Safety Instructions

1. Always read the safety instructions carefully.
2. Keep this User's Manual for future reference.
3. Keep this equipment away from humidity.
4. Lay this equipment on a reliable flat surface before setting it up.
5. The openings on the enclosure are for air convection hence protects the equipment from overheating. DO NOT COVER THE OPENINGS.
6. Make sure the voltage of the power source and adjust properly 110/220V before connecting the equipment to the power inlet.
7. Place the power cord such a way that people can not step on it. Do not place anything over the power cord.
8. Always Unplug the Power Cord before inserting any add-on card or module.
9. All cautions and warnings on the equipment should be noted.
10. Never pour any liquid into the opening that could damage or cause electrical shock.
11. If any of the following situations arises, get the equipment checked by a service personnel:
 - † The power cord or plug is damaged.
 - † Liquid has penetrated into the equipment.
 - † The equipment has been exposed to moisture.
 - † The equipment has not work well or you can not get it work according to User's Manual.
 - † The equipment has dropped and damaged.
 - † The equipment has obvious sign of breakage.
12. DO NOT LEAVE THIS EQUIPMENT IN AN ENVIRONMENT UNCONDITIONED, STORAGE TEMPERATURE ABOVE 60°C (140°F), IT MAY DAMAGE THE EQUIPMENT.



CAUTION: Danger of explosion if battery is incorrectly replaced. Replace only with the same or equivalent type recommended by the manufacturer.



警告使用者：
這是甲類的資訊產品，在居住的環境中使用時，可能會造成無線電干擾，在這種情況下，使用者會被要求採取某些適當的對策。



廢電池請回收

For better environmental protection, waste batteries should be collected separately for recycling or special disposal.

FCC-B Radio Frequency Interference Statement

This equipment has been tested and found to comply with the limits for a Class B digital device, pursuant to Part



15 of the FCC Rules. These limits are designed to provide reasonable protection against harmful interference in a residential installation. This equipment generates, uses and can radiate radio frequency energy and, if not installed and used in accordance with the instructions, may cause harmful interference to radio communications. However, there is no guarantee that interference will not occur in a particular installation. If this equipment does cause harmful interference to radio or television reception, which can be determined by turning the equipment off and on, the user is encouraged to try to correct the interference by one or more of the measures listed below.

- † Reorient or relocate the receiving antenna.
- † Increase the separation between the equipment and receiver.
- † Connect the equipment into an outlet on a circuit different from that to which the receiver is connected.
- † Consult the dealer or an experienced radio/television technician for help.

Notice 1

The changes or modifications not expressly approved by the party responsible for compliance could void the user's authority to operate the equipment.

Notice 2

Shielded interface cables and A.C. power cord, if any, must be used in order to comply with the emission limits.

VOIR LANOTICE D'INSTALLATIONAVANT DE RACCORDER AU RESEAU.



This device complies with Part 15 of the FCC Rules. Operation is subject to the following two conditions:

- (1) this device may not cause harmful interference, and*
- (2) this device must accept any interference received, including interference that may cause undesired operation.*

WEEE (Waste Electrical and Electronic Equipment) Statement



ENGLISH

To protect the global environment and as an environmentalist, MSI must remind you that...

Under the European Union ("EU") Directive on Waste Electrical and Electronic Equipment, Directive 2002/96/EC, which takes effect on August 13, 2005, products of "electrical and electronic equipment" cannot be discarded as municipal waste anymore and manufacturers of covered electronic equipment will be obligated to take back such products at the end of their useful life. MSI will comply with the product take back requirements at the end of life of MSI-branded products that are sold into the EU. You can return these products to local collection points.

DEUTSCH

Hinweis von MSI zur Erhaltung und Schutz unserer Umwelt

Gemäß der Richtlinie 2002/96/EG über Elektro- und Elektronik-Altgeräte dürfen Elektro- und Elektronik-Altgeräte nicht mehr als kommunale Abfälle entsorgt werden. MSI hat europaweit verschiedene Sammel- und Recyclingunternehmen beauftragt, die in die Europäische Union in Verkehr gebrachten Produkte, am Ende seines Lebenszyklus zurückzunehmen. Bitte entsorgen Sie dieses Produkt zum gegebenen Zeitpunkt ausschliesslich an einer lokalen Altgerätesammelstelle in Ihrer Nähe.

FRANÇAIS

En tant qu'écologiste et afin de protéger l'environnement, MSI tient à rappeler ceci...

Au sujet de la directive européenne (EU) relative aux déchets des équipements électriques et électroniques, directive 2002/96/EC, prenant effet le 13 août 2005, que les produits électriques et électroniques ne peuvent être déposés dans les décharges ou tout simplement mis à la poubelle. Les fabricants de ces équipements seront obligés de récupérer certains produits en fin de vie. MSI prendra en compte cette exigence relative au retour des produits en fin de vie au sein de la communauté européenne. Par conséquent vous pouvez retourner localement ces matériels dans les points de collecte.

РУССКИЙ

Компания MSI предпринимает активные действия по защите окружающей среды, поэтому напоминаем вам, что...

В соответствии с директивой Европейского Союза (ЕС) по предотвращению загрязнения окружающей среды использованным электрическим и электронным оборудованием (директива WEEE 2002/96/EC), вступающей в силу 13 августа 2005 года, изделия, относящиеся к электрическому и электронному оборудованию, не могут рассматриваться как бытовой мусор, поэтому производители вышеперечисленного электронного оборудования обязаны принимать его для переработки по окончании срока службы. MSI обязуется соблюдать требования по приему продукции, проданной под маркой MSI на территории ЕС, в переработку по окончании срока службы. Вы можете вернуть эти изделия в специализированные пункты приема.

ESPAÑOL

MSI como empresa comprometida con la protección del medio ambiente, recomienda:

Bajo la directiva 2002/96/EC de la Unión Europea en materia de desechos y/o equipos electrónicos, con fecha de rigor desde el 13 de agosto de 2005, los productos clasificados como "eléctricos y equipos electrónicos" no pueden ser depositados en los contenedores habituales de su municipio, los fabricantes de equipos electrónicos, están obligados a hacerse cargo de dichos productos al término de su período de vida. MSI estará comprometido con los términos de recogida de sus productos vendidos en la Unión Europea al final de su período de vida. Usted debe depositar estos productos en el punto limpio establecido por el ayuntamiento de su localidad o entregar a una empresa autorizada para la recogida de estos residuos.

NEDERLANDS

Om het milieu te beschermen, wil MSI u eraan herinneren dat...

De richtlijn van de Europese Unie (EU) met betrekking tot Vervuiling van Elektrische en Electronische producten (2002/96/EC), die op 13 Augustus 2005 in zal gaan kunnen niet meer beschouwd worden als vervuiling.

Fabrikanten van dit soort producten worden verplicht om producten retour te nemen aan het eind van hun levenscyclus. MSI zal overeenkomstig de richtlijn handelen voor de producten die de merknaam MSI dragen en verkocht zijn in de EU. Deze goederen kunnen geretourneerd worden op lokale inzamelingspunten.

SRPSKI

Da bi zaštitili prirodnu sredinu, i kao preduzeće koje vodi računa o okolini i prirodnoj sredini, MSI mora da vas podesti da...

Po Direktivi Evropske unije ("EU") o odbačenju elektonskoj i električnoj opremi, Direktiva 2002/96/EC, koja stupa na snagu od 13. Avgusta 2005, proizvodi koji spadaju pod "elektonsku i električnu opremu" ne mogu više biti odbačeni kao običan otpad i proizvođači ove opreme biće prinuđeni da uzmu natrag ove proizvode na kraju njihovog uobičajenog veka trajanja. MSI će poštovati zahtev o preuzimanju ovakvih proizvoda kojima je istekao vek trajanja, koji imaju MSI oznaku i koji su prodati u EU. Ove proizvode možete vratiti na lokalnim mestima za prikupljanje.

POLSKI

Aby chronić nasze środowisko naturalne oraz jako firma dbająca o ekologię, MSI przypomina, że...

Zgodnie z Dyrektywą Unii Europejskiej ("UE") dotyczącą odpadów produktów elektrycznych i elektronicznych (Dyrektywa 2002/96/EC), która wchodzi w życie 13 sierpnia 2005, tzw. "produkty oraz wyposażenie elektryczne i elektroniczne" nie mogą być traktowane jako śmieci komunalne, tak więc producenci tych produktów będą zobowiązani do odbierania ich w momencie gdy produkt jest wycofywany z użycia. MSI wypełni wymagania UE, przyjmując produkty (sprzedawane na terenie Unii Europejskiej) wycofywane z użycia. Produkty MSI będzie można zwracać w wyznaczonych punktach zbiorczych.

TÜRKÇE

Çevreci özelliğiyle bilinen MSI dünyada çevreyi korumak için hatırlatır:

Avrupa Birliği (AB) Kararnamesi Elektrik ve Elektronik Malzeme Atığı, 2002/96/EC Kararnamesi altında 13 Ağustos 2005 tarihinden itibaren geçerli olmak üzere, elektrikli ve elektronik malzemeler diğer atıklar gibi çöpe atılmayacak ve bu elektronik cihazların üreticileri, cihazların kullanım süreleri bittikten sonra ürünleri geri toplamakla yükümlü olacaktır. Avrupa Birliği'ne satılan MSI markalı ürünlerin kullanım süreleri bittiğinde MSI ürünlerin geri alınması isteği ile işbirliği içerisinde olacaktır. Ürünlerinizi yerel toplama noktalarına bırakabilirsiniz.

ČESKY

Záleží nám na ochraně životního prostředí - společnost MSI upozorňuje...

Podle směrnice Evropské unie ("EU") o likvidaci elektrických a elektronických výrobků 2002/96/EC platné od 13. srpna 2005 je zakázáno likvidovat "elektrické a elektronické výrobky" v běžném komunálním odpadu a výrobci elektronických výrobků, na které se tato směrnice vztahuje, budou povinni odebrat takové výrobky zpět po skončení jejich životnosti. Společnost MSI splní požadavky na odebrání výrobků značky MSI, prodávaných v zemích EU, po skončení jejich životnosti. Tyto výrobky můžete odevzdat v místních sběrnách.

MAGYAR

Annak érdekében, hogy környezetünk megvédjük, illetve környezetvédként fellépve az MSI emlékezteti Önt, hogy ...

Az Európai Unió („EU”) 2005. augusztus 13-án hatályba lépő, az elektromos és elektronikus berendezések hulladékairól szóló 2002/96/EK irányelve szerint az elektromos és elektronikus berendezések többé nem kezelhetők lakossági hulladékként, és az ilyen elektronikus berendezések gyártói kötelessé válnak az ilyen termékek visszavételére azok hasznos élettartama végén. Az MSI betartja a termék visszavétellel kapcsolatos követelményeket az MSI márkánév alatt az EU-n belül értékesített termékek esetében, azok élettartamának végén. Az ilyen termékeket a legközelebbi gyűjtőhelyre viheti.

ITALIANO

Per proteggere l'ambiente, MSI, da sempre amica della natura, ti ricorda che....

In base alla Direttiva dell'Unione Europea (EU) sullo Smaltimento dei Materiali Elettrici ed Elettronici, Direttiva 2002/96/EC in vigore dal 13 Agosto 2005, prodotti appartenenti alla categoria dei Materiali Elettrici ed Elettronici non possono più essere eliminati come rifiuti municipali: i produttori di detti materiali saranno obbligati a ritirare ogni prodotto alla fine del suo ciclo di vita. MSI si adegnerà a tale Direttiva ritirando tutti i prodotti marchiati MSI che sono stati venduti all'interno dell'Unione Europea alla fine del loro ciclo di vita. È possibile portare i prodotti nel più vicino punto di raccolta.

CONTENTS

Copyright Notice	ii
Trademarks	ii
Revision History	ii
Technical Support	ii
Safety Instructions	iii
FCC-B Radio Frequency Interference Statement	iv
WEEE (Waste Electrical and Electronic Equipment) Statement	v
Chapter 1. Getting Started	1-1
Mainboard Specifications	1-2
Mainboard Layout	1-4
Packing Checklist	1-5
Chapter 2. Hardware Setup	2-1
Quick Components Guide	2-2
CPU (Central Processing Unit)	2-3
Memory	2-6
Power Supply	2-8
Back Panel	2-9
Connectors	2-11
Jumper	2-18
Button	2-19
Slots	2-20
Chapter 3 BIOS Setup	3-1
Entering Setup	3-2
The Main Menu	3-4
Standard CMOS Features	3-6
Advanced BIOS Features	3-8
Integrated Peripherals	3-10
Power Management Setup	3-12
PNP/PCI Configurations	3-15
H/W Monitor	3-17
Cell Menu	3-18
USERSETTINGS	3-22
Load Fail-Safe/ Optimized Defaults	3-23
BIOS Setting Password	3-24
Appendix A Realtek Audio	A-1
Installing the Realtek HD Audio Driver	A-2
Software Configuration	A-4

Hardware Setup	A-19
Appendix B Dual Core Center	B-1
Activating Dual Core Center	B-2
Main	B-3
DOT(Dyanmic OverClocking)	B-5
Clock	B-6
Voltage	B-7
FAN Speed	B-8
Temperature	B-9
User Profile	B-10
Appendix C SATA RAID	C-1
RAID Configuration	C-2

Chapter 1

Getting Started

Thank you for choosing the K9A2 Platinum Series (MS-7376 v1.X) ATX mainboards. The K9A2 Platinum Series mainboards are based on **AMD® 790FX & SB600** chipsets for optimal system efficiency. Designed to fit the advanced **AMD® Phenom/Athlon/Sempron** processors in socket AM2+, the K9A2 Platinum Series deliver a high performance and professional desktop platform solution.

Mainboard Specifications

Processor Support

- AMD® Phenom/Athlon/Sempron in the Socket AM2+ package.
- Supports 4 pin CPU Fan Pin-Header with Fan Speed Control
(For the latest information about CPU, please visit <http://global.msi.com.tw/index.php?func=cpuform>)

Supported FSB

- HyperTransport 3.0 supports speed up to 2600 MHz

Chipset

- North Bridge: AMD® 790FX chipset
- South Bridge: AMD® SB600 chipset

Memory Support

- DDR2 1066/800/667/533 DRAM (240pin/ 1.8V)
- 4 DDR2 DIMMs (8GB Max)
(For more information on compatible components, please visit <http://global.msi.com.tw/index.php?func=testreport>)

LAN

- Supports 10/100/1000 Fast Ethernet by Realtek 8111B

1394 (Optional)

- Transfer rate is up to 400Mbps
- Controlled by VIA VT6308P (optional)

Audio

- Chip integrated by Realtek® ALC888/ ALC888T (optional)
- Flexible 8-channel audio with jack sensing
- Compliant with Azalia 1.0 spec

IDE

- 1 IDE port by SB600
- Supports Ultra DMA 66/100/133 mode
- Supports PIO, Bus Master operation mode

SATA

- 4 SATAII ports by SB600 (SATA1~4)
- 2 SATAII ports by Promise T3 (SATA5~6), support SAS ready device
- 2 eSATA ports by Promise T3
- Supports storage and data transfers at up to 300MB/s
- 2 SATA (SATA5 & SATA6) ports and 2 eSATA ports by Promise T3 support to install storage devices only

Floppy

- 1 floppy port
- Supports 1 FDD with 360KB, 720KB, 1.2MB, 1.44MB and 2.88MB

RAID
<ul style="list-style-type: none">- SATA1~4 support RAID 0/ 1/ 0+1 mode- SATS5~6 & 2 eSATA ports support RAID0/ 1/ 0+1 mode
Connectors
<ul style="list-style-type: none">● Back panel<ul style="list-style-type: none">- 1 PS/2 mouse port- 1 PS/2 keyboard port- 1 1394 port (optional)- 1 Optical SPDIF-out jack- 2 eSATA ports- 1 LAN jack- 4 USB 2.0 ports- 6 flexible audio jacks● On-Board Pinheaders<ul style="list-style-type: none">- 3 USB 2.0 pinheaders- 1 1394 pinheader (optional)- 1 Serial port pinheader (optional)- 1 Front Panel Audio pinheader- 1 CD-in pinheader- 1 TPM Module pinheader (optional)- 1 VoIP card pinheader (optional)- 1 S/PDIF-out pinheader
TPM (optional)
<ul style="list-style-type: none">- Supports TPM
Slots
<ul style="list-style-type: none">- 4 PCI Express x16 slots compatible with PCIE 2.0 spec<ol style="list-style-type: none">a. the mazarine PCIE x16 slots (PCI_EX1/ PCI_EX4) support up to PCIE 2.0x16 speedb. for CrossFire mode, please install both graphics cards on both mazarine PCIE x16 slotsc. the blue PCIE x16 slots (PCI_EX3/ PCI_EX5) are special design that support up to PCIE 2.0x8 speedd. to use all 4 PCIE x16 slots or to use both blue PCIE x16 slots, the PCIE x 16 lanes will auto arrange from x16/ x0/ x16/ x0 to x8/ x8/ x8/ x8- 1 PCI Express x 1 slot- 2 PCI slots
Form Factor
<ul style="list-style-type: none">- ATX (30.5cm X 24.5 cm)
Mounting
<ul style="list-style-type: none">- 9 mounting holes

MS-7376 Mainboard

Mainboard Layout

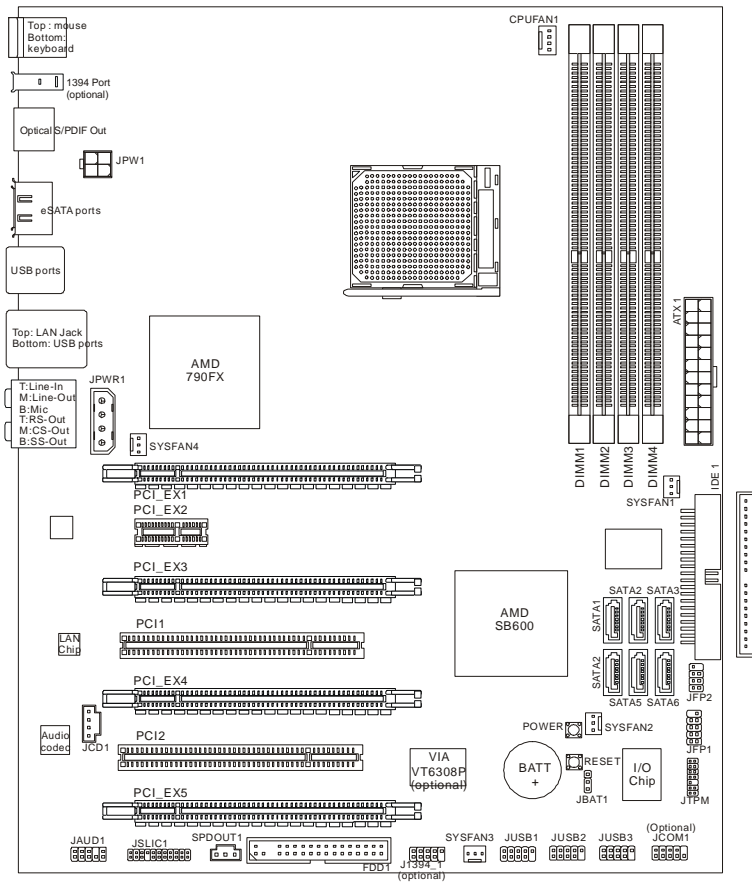

K9A2 Platinum Series (MS-7376 v1.X)
ATX Mainboard

Packing Checklist



MSI motherboard

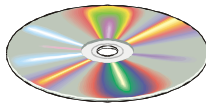

MSI Driver/Utility CD



Back IO Shield



Power Cable



SATA Cable



IDE Cable



Floppy Cable



external SATA Cable
(optional)



1394+USB Bracket



User's Guide
and Quick Guide



Cross Fire
Video Link Cable

* The pictures are for reference only and may vary from the packing contents of the product you purchased.

Chapter 2

Hardware Setup

This chapter provides you with the information about hardware setup procedures. While doing the installation, be careful in holding the components and follow the installation procedures. For some components, if you install in the wrong orientation, the components will not work properly.

Use a grounded wrist strap before handling computer components. Static electricity may damage the components.

Quick Components Guide

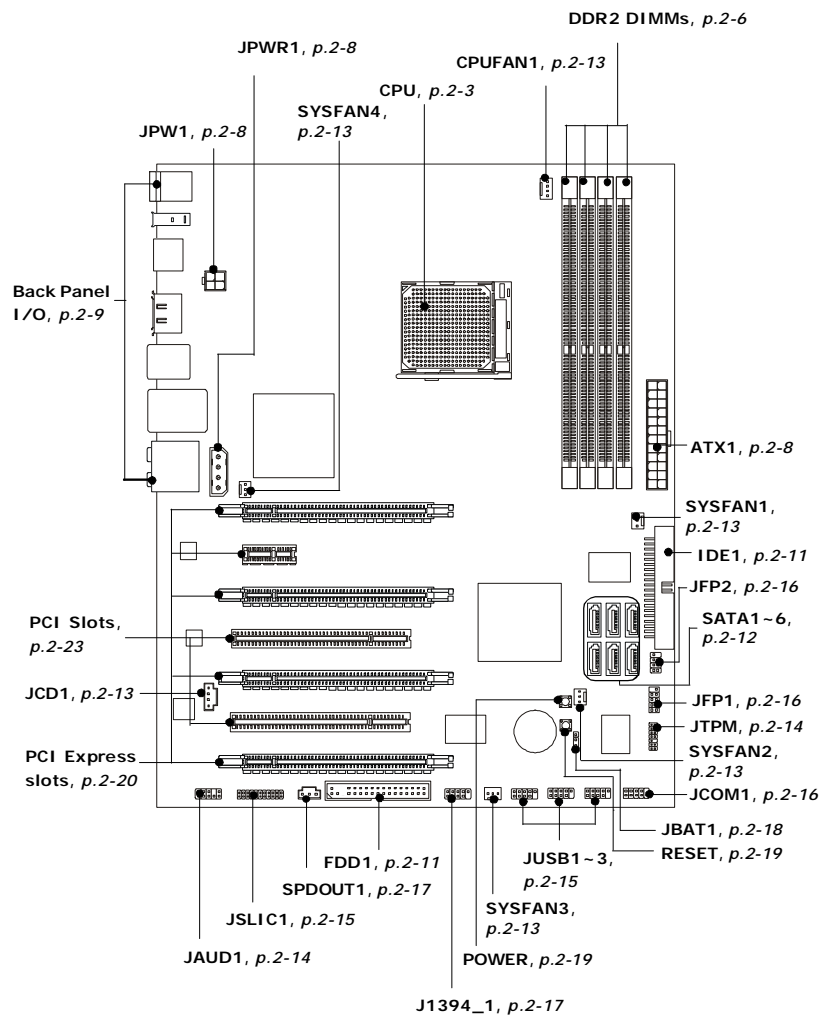

CPU (Central Processing Unit)

The mainboard supports AMD® Phenom/Athlon/Sempron processors. The mainboard uses a CPU socket called Socket AM2+ for easy CPU installation. When you are installing the CPU, **make sure the CPU has a heat sink and a cooling fan attached on the top to prevent overheating.** If you do not have the heat sink and cooling fan, contact your dealer to purchase and install them before turning on the computer.

For the latest information about CPU, please visit <http://global.msi.com.tw/index.php?func=cpuform>



Important

Overheating

Overheating will seriously damage the CPU and system. Always make sure the cooling fan can work properly to protect the CPU from overheating. Make sure that you apply an even layer of thermal paste (or thermal tape) between the CPU and the heatsink to enhance heat dissipation.

Replacing the CPU

While replacing the CPU, always turn off the ATX power supply or unplug the power supply's power cord from the grounded outlet first to ensure the safety of CPU.

Overclocking

*This mainboard is designed to support overclocking. However, please make sure your components are able to tolerate such abnormal setting, while doing overclocking. Any attempt to operate beyond product specifications is not recommended. **We do not guarantee the damages or risks caused by inadequate operation or beyond product specifications.***

CPU Installation Procedures for Socket AM2+

1. Please turn off the power and unplug the power cord before installing the CPU.
2. Pull the lever sideways away from the socket. Make sure to raise the lever up to a 90-degree angle.
3. Look for the gold arrow on the CPU. The gold arrow should point as shown in the picture. The CPU can only fit in the correct orientation. Lower the CPU down onto the socket.
4. If the CPU is correctly installed, the pins should be completely embedded into the socket and can not be seen. Please note that any violation of the correct installation procedures may cause permanent damages to your mainboard.
5. Press the CPU down firmly into the socket and close the lever. As the CPU is likely to move while the lever is being closed, always close the lever with your fingers pressing tightly on top of the CPU to make sure the CPU is properly and completely embedded into the socket.

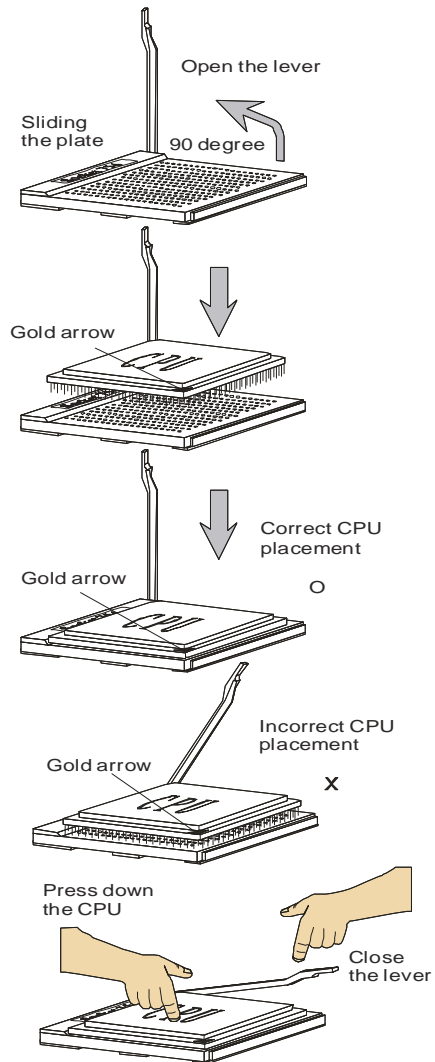

Installing AMD Socket AM2+ CPU Cooler Set

When you are installing the CPU, **make sure the CPU has a heat sink and a cooling fan attached on the top to prevent overheating.** If you do not have the heat sink and cooling fan, contact your dealer to purchase and install them before turning on the computer.



Important

1. Read the CPU status in BIOS (Chapter 3).
2. Mainboard photos shown in this section are for demonstration of the CPU/cooler installation only. The appearance of your mainboard may vary depending on the model you purchase.

1. Position the cooling set onto the retention mechanism.

Hook one end of the clip to hook first.

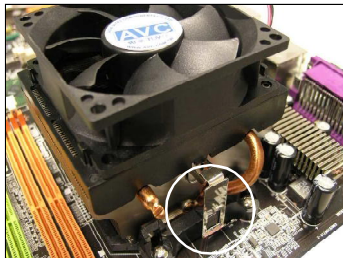

2. Then press down the other end of the clip to fasten the cooling set on the top of the retention mechanism. Locate the Fix Lever and lift up it .

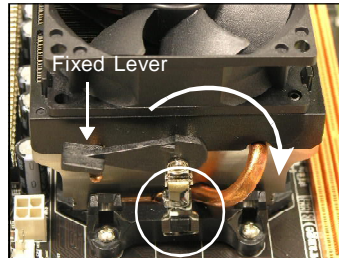

3. Fasten down the lever.

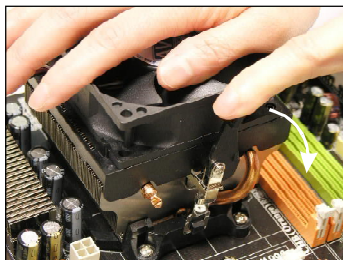

4. Attach the CPU Fan cable to the CPU fan connector on the mainboard.

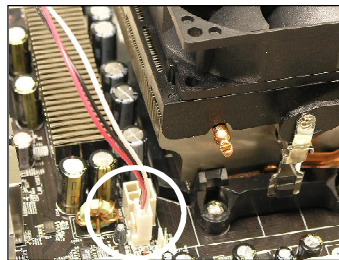

Memory

These DIMM slots are used for installing memory modules.

For more information on compatible components, please visit <http://global.msi.com.tw/index.php?func=testreport>

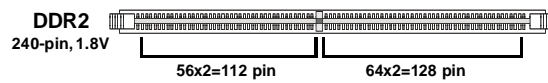

Dual-Channel Memory Population Rules

In Dual-Channel mode, the memory modules can transmit and receive data with two data bus lines simultaneously. Enabling Dual-Channel mode can enhance the system performance. Please refer to the following illustrations for population rules under Dual-Channel mode.

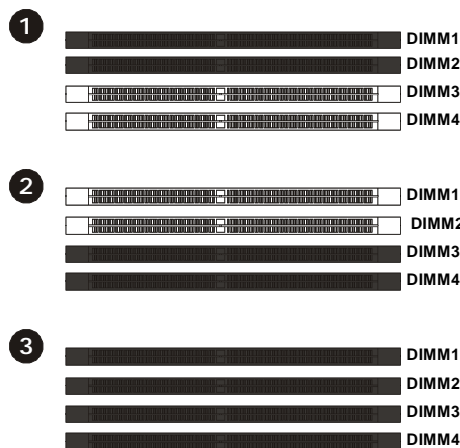

Installing Memory Modules

1. The memory module has only one notch on the center and will only fit in the right orientation.
2. Insert the memory module vertically into the DIMM slot. Then push it in until the golden finger on the memory module is deeply inserted in the DIMM slot.



Important

You can barely see the golden finger if the memory module is properly inserted in the DIMM slot.

3. The plastic clip at each side of the DIMM slot will automatically close.

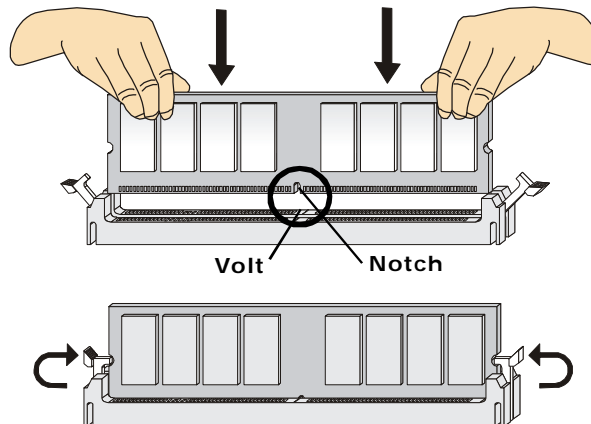

Important

- DDR2 memory modules are not interchangeable with DDR and the DDR2 standard is not backwards compatible. You should always install DDR2 memory modules in the DDR2 DIMM slots.
- In Dual-Channel mode, make sure that you install memory modules of **the same type and density** in different channel DIMM slots.
- To enable successful system boot-up, always insert the memory modules into the **DIMM1 first**.
- Due to the chipset resource deployment, the system density will only be detected up to 7+GB (not full 8GB) when each DIMM is installed with a 2GB memory module.

Power Supply

ATX 24-Pin Power Connector: ATX1

This connector allows you to connect an ATX 24-pin power supply. To connect the ATX 24-pin power supply, make sure the plug of the power supply is inserted in the proper orientation and the pins are aligned. Then push down the power supply firmly into the connector.

You may use the 20-pin ATX power supply as you like. If you'd like to use the 20-pin ATX power supply, please plug your power supply along with pin 1 & pin 13 (refer to the image at the right hand). There is also a foolproof design on pin 11, 12, 23 & 24 to avoid wrong installation.



Pin Definition

ATX1		Pin Definition			
PIN	SIGNAL	PIN	SIGNAL		
1	+3.3V	13	+3.3V		
2	+3.3V	14	-12V		
3	GND	15	GND		
4	+5V	16	PS-ON#		
5	GND	17	GND		
6	+5V	18	GND		
7	GND	19	GND		
8	PWROK	20	Res		
9	5VSB	21	+5V		
10	+12V	22	+5V		
11	+12V	23	+5V		
12	+3.3V	24	GND		

ATX Power Connector: JPW1/ JPWR1

This 12V power connector JPW1 is used to provide power to the CPU. This power connector JPWR1 is used to provide power to stable the operation of graphics card.

JPW1	JPW1 Pin Definition	JPWR1	JPWR1 Pin Definition																				
	<table border="1"> <thead> <tr> <th>PIN</th> <th>SIGNAL</th> </tr> </thead> <tbody> <tr> <td>1</td> <td>GND</td> </tr> <tr> <td>2</td> <td>GND</td> </tr> <tr> <td>3</td> <td>12V</td> </tr> <tr> <td>4</td> <td>12V</td> </tr> </tbody> </table>	PIN	SIGNAL	1	GND	2	GND	3	12V	4	12V		<table border="1"> <thead> <tr> <th>PIN</th> <th>SIGNAL</th> </tr> </thead> <tbody> <tr> <td>1</td> <td>NC</td> </tr> <tr> <td>2</td> <td>GND</td> </tr> <tr> <td>3</td> <td>GND</td> </tr> <tr> <td>4</td> <td>12V</td> </tr> </tbody> </table>	PIN	SIGNAL	1	NC	2	GND	3	GND	4	12V
PIN	SIGNAL																						
1	GND																						
2	GND																						
3	12V																						
4	12V																						
PIN	SIGNAL																						
1	NC																						
2	GND																						
3	GND																						
4	12V																						



Important

1. Make sure that all the connectors are connected to proper ATX power supplies to ensure stable operation of the mainboard.
2. Power supply of 450 watts (and above) is highly recommended for system stability.

Back Panel

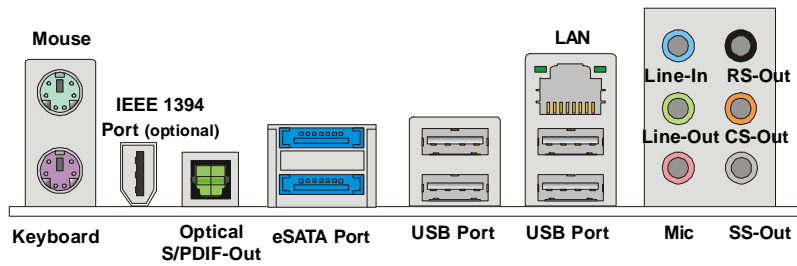

► **Mouse/Keyboard**

The standard PS/2® mouse/keyboard DIN connector is for a PS/2® mouse/keyboard.

► **IEEE 1394 Port (optional)**

The 1394 port on the back panel provides connection to 1394 devices.

► **Optical S/PDIF-Out**

This SPDIF (Sony & Philips Digital Interconnect Format) connector is provided for digital audio transmission to external speakers through an optical fiber cable.

► **eSATA Port**

The eSATA port is for attaching the eSATA external hard drive.

► **USB Port**

The USB (Universal Serial Bus) port is for attaching USB devices such as keyboard, mouse, or other USB-compatible devices.

► **LAN**

The standard RJ-45 LAN jack is for connection to the Local Area Network (LAN). You can connect a network cable to it.

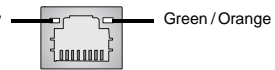

LED	Color	LED State	Condition
Left	Orange	Off	LAN link is not established.
		On (steady state)	LAN link is established.
		On (brighter & pulsing)	The computer is communicating with another computer on the LAN.
Right	Green	Off	10 Mbit/sec data rate is selected.
		On	100 Mbit/sec data rate is selected.
	Orange	On	1000 Mbit/sec data rate is selected.

► **Audio Ports**

These audio connectors are used for audio devices. You can differentiate the color of the audio jacks for different audio sound effects.

- **Line-In (Blue)** - Line In, is used for external CD player, tapeplayer or other audio devices.
- **Line-Out (Green)** - Line Out, is a connector for speakers or headphones.
- **Mic (Pink)** - Mic, is a connector for microphones.
- **RS-Out (Black)** - Rear-Surround Out in 4/ 5.1/ 7.1 channel mode.
- **CS-Out (Orange)** - Center/ Subwoofer Out in 5.1/ 7.1 channel mode.
- **SS-Out (Gray)** - Side-Surround Out 7.1 channel mode.

Connectors

Floppy Disk Drive Connector: FDD1

This connector supports 360KB, 720KB, 1.2MB, 1.44MB or 2.88MB floppy disk drive.

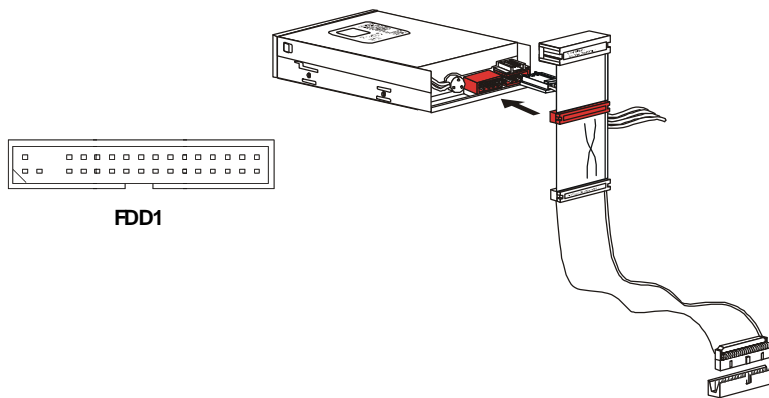

IDE Connector: IDE1

This connector supports IDE hard disk drives, optical disk drives and other IDE devices.

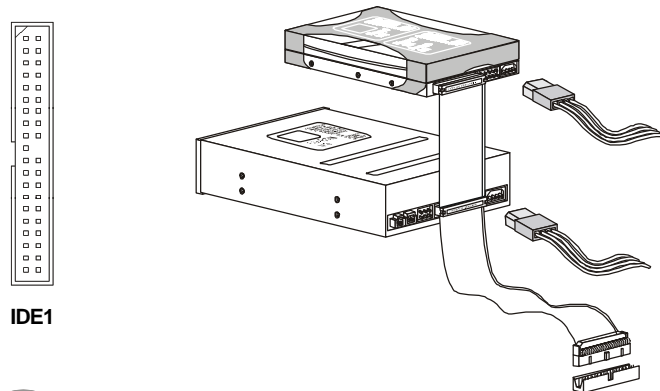

Important

If you install two IDE devices on the same cable, you must configure the drives separately to master / slave mode by setting jumpers. Refer to IDE device's documentation supplied by the vendors for jumper setting instructions.

Serial ATA Connector: SATA1/ SATA2/ SATA3/ SATA4/ SATA5/ SATA6

This connector is a high-speed Serial ATA interface port. Each connector can connect to one Serial ATA device.

SATA1/2/3/4 connectors are supported by SB600

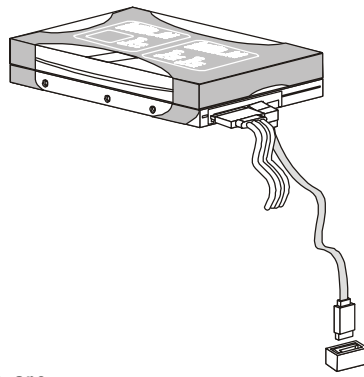
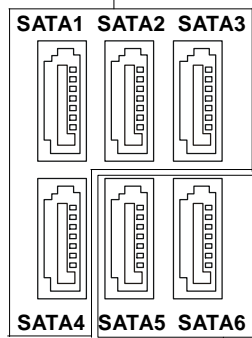

SATA5/6 connectors are supported by Promise T3



Important

Please do not fold the Serial ATA cable into 90-degree angle. Otherwise, data loss may occur during transmission.

Fan Power Connectors: CPUFAN1, SYSFAN1~4

The fan power connectors support system cooling fan with +12V. When connecting the wire to the connectors, always note that the red wire is the positive and should be connected to the +12V; the black wire is Ground and should be connected to GND. If the mainboard has a System Hardware Monitor chipset on-board, you must use a specially designed fan with speed sensor to take advantage of the CPU fan control.

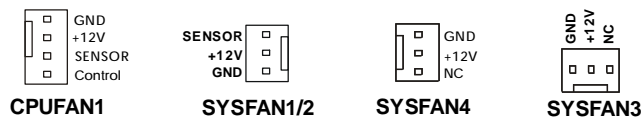

Important

1. Please refer to the recommended CPU fans at processor's official website or consult the vendors for proper CPU cooling fan.
2. CPUFAN1 supports fan control. You can install **Dual Core Center** utility that will automatically control the CPU fan speed according to the actual CPU temperature.
3. Fan/heatsink with 3 or 4 pins are both available for CPUFAN1.

CD-In Connector: JCD1

This connector is provided for external audio input..

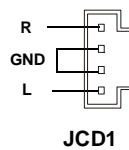

Front Panel Audio Connector: JAUD1

This connector allows you to connect the front panel audio and is compliant with Intel® Front Panel I/O Connectivity Design Guide.

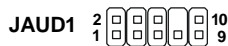

Pin Definition

PIN	SIGNAL	DESCRIPTION
1	AUD_MIC	Front panel microphone input signal
2	AUD_GND	Ground used by analog audio circuits
3	AUD_MIC_BIAS	Microphone power
4	AUD_VCC	Filtered +5V used by analog audio circuits
5	AUD_FPOUT_R	Right channel audio signal to front panel
6	AUD_RET_R	Right channel audio signal return from front panel
7	HP_ON	Reserved for future use to control headphone amplifier
8	KEY	No pin
9	AUD_FPOUT_L	Left channel audio signal to front panel
10	AUD_RET_L	Left channel audio signal return from front panel

TPM Module Connector: JTPM (optional)

This connector connects to a TPM (Trusted Platform Module) module (optional). Please refer to the TPM security platform manual for more details and usages.

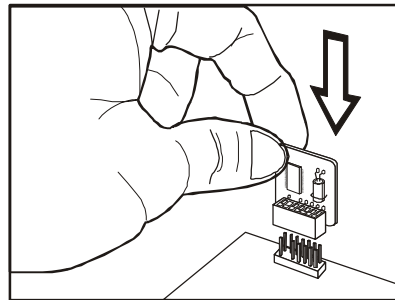
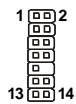

Pin	Signal	Description	Pin	Signal	Description
1	LCLK	LPC clock	2	3V dual/3V_STB	3V dual or 3V standby power
3	LRST#	LPC reset	4	VCC3	3.3V power
5	LAD0	LPC address & data pin0	6	SIRQ	Serial IRQ
7	LAD1	LPC address & data pin1	8	VCC5	5V power
9	LAD2	LPC address & data pin2	10	KEY	No pin
11	LAD3	LPC address & data pin3	12	GND	Ground
13	LFRAME#	LPC Frame	14	GND	Ground

Front USB Connector: JUSB1 / JUSB2 / JUSB3

This connector, compliant with Intel® I/O Connectivity Design Guide, is ideal for connecting high-speed USB interface peripherals such as **USB HDD, digital cameras, MP3 players, printers, modems and the like.**

Pin Definition

PIN	SIGNAL	PIN	SIGNAL
1	VCC	2	VCC
3	USB0-	4	USB1-
5	USB0+	6	USB1+
7	GND	8	GND
9	Key (no pin)	10	USBOC

JUSB1/2/3



1394+USB Bracket (Optional)

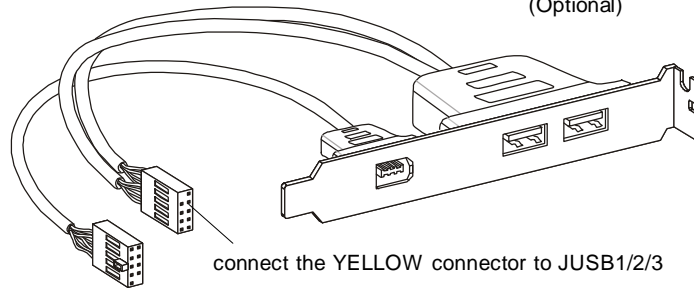

Important

Note that the pins of VCC and GND must be connected correctly to avoid possible damage.

VoIP Card Connector: JSLIC1 (optional, for ALC888T only)

This connector connects to the VoIP card. Please refer to the instruction of the VoIP card.

JSLIC1



Front Panel Connectors: JFP1, JFP2

These connectors are for electrical connection to the front panel switches and LEDs. The JFP1 is compliant with Intel® Front Panel I/O Connectivity Design Guide.

JFP1 Pin Definition

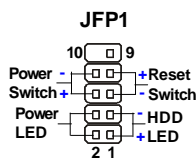

PIN	SIGNAL	DESCRIPTION
1	HD_LED +	Hard disk LED pull-up
2	FP PWR/SLP	MSG LED pull-up
3	HD_LED -	Hard disk active LED
4	FP PWR/SLP	MSG LED pull-up
5	RST_SW -	Reset Switch low reference pull-down to GND
6	PWR_SW+	Power Switch high reference pull-up
7	RST_SW +	Reset Switch high reference pull-up
8	PWR_SW-	Power Switch low reference pull-down to GND
9	RSVD_DNU	Reserved. Do not use.

JFP2 Pin Definition

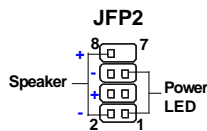

PIN	SIGNAL	DESCRIPTION
1	GND	Ground
2	SPK-	Speaker-
3	SLED	Suspend LED
4	BUZ+	Buzzer+
5	PLED	Power LED
6	BUZ-	Buzzer-
7	NC	No connection
8	SPK+	Speaker+

Serial Port Connector: JCOM1 (optional)

This connector is a 16550A high speed communication port that sends/receives 16 bytes FIFOs. You can attach a serial device.

Pin Definition

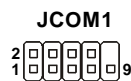

PIN	SIGNAL	DESCRIPTION
1	DCD	Data Carry Detect
2	SIN	Serial In or Receive Data
3	SOUT	Serial Out or Transmit Data
4	DTR	Data Terminal Ready
5	GND	Ground
6	DSR	Data Set Ready
7	RTS	Request To Send
8	CTS	Clear To Send
9	RI	Ring Indicate

IEEE1394 Connector: J1394_1 (optional)

This connector allows you to connect the IEEE1394 device via an optional IEEE1394 bracket.

Pin Definition

PIN	SIGNAL	PIN	SIGNAL
1	TPA+	2	TPA-
3	Ground	4	Ground
5	TPB+	6	TPB-
7	Cablepower	8	Cablepower
9	Key (no pin)	10	Ground

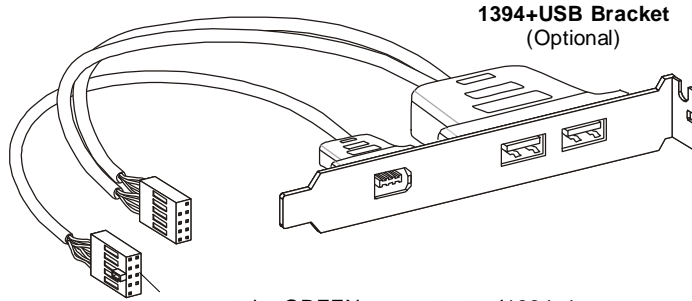
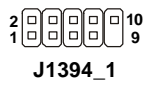

connect the GREEN connector to J1394_1r

S/PDIF-Out Connector: SPDOUT1

This connector is used to connect S/PDIF (Sony & Philips Digital Interconnect Format) interface for digital audio transmission.

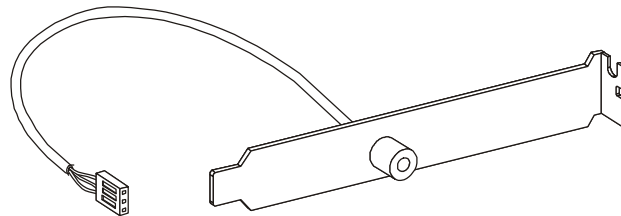
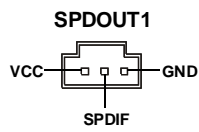

Jumper

Clear CMOS Jumper: JBAT1

There is a CMOS RAM onboard that has a power supply from an external battery to keep the data of system configuration. With the CMOS RAM, the system can automatically boot OS every time it is turned on. If you want to clear the system configuration, set the jumper to clear data.

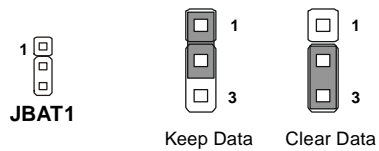

Important

You can clear CMOS by shorting 2-3 pin while the system is off. Then return to 1-2 pin position. Avoid clearing the CMOS while the system is on; it will damage the mainboard.

Button

The motherboard provides the following buttons for you to set the computer's function. This section will explain how to change your motherboard's function through the use of button.

Power Button: POWER

This power button is used to turn-on or turn-off the system. Press the button to turn-on or turn-off the system.



POWER

Reset Button: RESET

This reset button is used to reset the system. Press the button to reset the system.



RESET

Slots

PCI (Peripheral Component Interconnect) Express Slot

The PCI Express slot supports the PCI Express interface expansion card.

The PCI Express 2.0x 16 supports up to 8.0 GB/s transfer rate.

The PCI Express 2.0x 8 supports up to 4.0 GB/s transfer rate.

The PCI Express x1 supports up to 250 MB/s transfer rate.

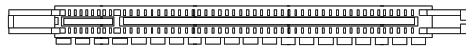

Mazarine PCI Express x16 Slots support up to PCI Express 2.0x16 speed (PCI_EX1 & PCI_EX4)

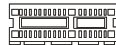

White PCI Express x 1 Slot supports PCI Express x1 speed (PCI_EX2)

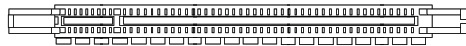

Blue PCI Express x 16 Slots support up to PCI Express 2.0x8 speed (PCI_EX3 & PCI_EX5)



Important

When adding or removing expansion cards, make sure that you unplug the power supply first. Meanwhile, read the documentation for the expansion card to configure any necessary hardware or software settings for the expansion card, such as jumpers, switches or BIOS configuration.

ATi CrossFire (Multi-GPU) Technology

ATi CrossFire (Multi-GPU) technology is an exciting new technology developed by ATI that allows the power of multiple Graphics. CrossFire requires a CrossFire Edition graphics card and a compatible standard Radeon (CrossFire Ready) graphics card from the same series. To utilize this technology, always install the CrossFire Edition graphics card in the first mazarine PCIE X16 (PCI_EX1) slot and install the CrossFire Ready graphics card in the second mazarine PCIE X16 (PCI_EX4) slot. The mainboard can auto detect the CrossFire mode by software, therefore you don't have to enable the CrossFire in BIOS by yourself. Following the process below to complete CrossFire:

1. Install the CrossFire **Edition** graphics card in the **First mazarine** PCIEx16 (PCI_EX1) slot and install the CrossFire **Ready** graphics card in the **Second mazarine** PCIEx16 (PCI_EX4) slot.
2. With two cards installed, an Cross Fire Video Link cable is required to connect the golden fingers on the top of these two graphics cards (refer to the picture below). Please note that although you have installed two graphics cards, only the video outputs on the CrossFire Edition graphics card will work. Hence, you only need to connect a monitor to the CrossFire Edition graphics card.

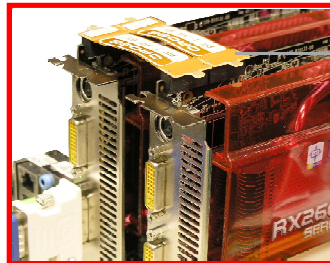

Cross Fire Video Link cable



Important

1. Mainboard photos shown in this section are for demonstration only. The appearance of your mainboard may vary depending on the model you purchase.
2. If you intend to install **TWO** graphics cards for Cross Fire mode, make sure that:
 - a. these two graphics cards are of the same brand and specifications;
 - b. these two cards are installed on both **mazarine** PCIE x16 slots.
3. If you intend to install only **ONE** graphics card, make sure that:
 - a. the graphics card is Installed on **first mazarine** PCIE x16 slot (PCI_EX1);
4. Only Windows® XP with Service Pack 2 (SP2) & Windows® XP Professional x64 Edition & Windows® Vista support the CrossFire function.

MS-7376 Mainboard

3. When all of the hardware and software has been properly set up and installed, reboot the system. After entering the O.S., click the "Catalyst™ Control Center" icon  on the desktop. There is a setting in the Catalyst™ Control Center that needs to be enabled for CrossFire™ to operate. The following aspect appears in Catalyst™ Control Center:

Select the Advanced View from the view drop menu.

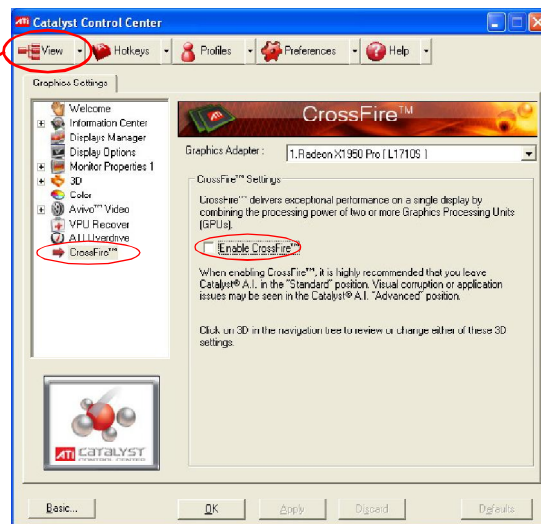

Important

A CrossFire™ system has four possible display modes:

- SuperTiling
- Scissor Mode
- Alternate Frame Rendering
- Super Anti-aliasing.

for more details, please consult the graphics card manual from the manufacturer.

PCI (Peripheral Component Interconnect) Slot

The PCI slot supports LAN card, SCSI card, USB card, and other add-on cards that comply with PCI specifications.

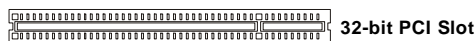

PCI Interrupt Request Routing

The IRQ, acronym of interrupt request line and pronounced I-R-Q, are hardware lines over which devices can send interrupt signals to the microprocessor. The PCI IRQ pins are typically connected to the PCI bus pins as follows:

	Order 1	Order 2	Order 3	Order 4
PCI Slot 1	INTG#	INTH#	INTE#	INTF#
PCI Slot 2	INTF#	INTG#	INTH#	INTE#



Important

When adding or removing expansion cards, make sure that you unplug the power supply first. Meanwhile, read the documentation for the expansion card to configure any necessary hardware or software settings for the expansion card, such as jumpers, switches or BIOS configuration.

Chapter 3

BIOS Setup

This chapter provides information on the BIOS Setup program and allows you to configure the system for optimum use.

You may need to run the Setup program when:

- ≈ An error message appears on the screen during the system booting up, and requests you to run SETUP.
- ≈ You want to change the default settings for customized features.

Entering Setup

Power on the computer and the system will start POST (Power On Self Test) process. When the message below appears on the screen, press key to enter Setup.

Press DEL to enter SETUP

If the message disappears before you respond and you still wish to enter Setup, restart the system by turning it OFF and On or pressing the RESET button. You may also restart the system by simultaneously pressing <Ctrl>, <Alt>, and <Delete> keys.



Important

1. The items under each BIOS category described in this chapter are under continuous update for better system performance. Therefore, the description may be slightly different from the latest BIOS and should be held for reference only.
2. Upon boot-up, the 1st line appearing after the memory count is the BIOS version. It is usually in the format:

A7376AMS V1.0 122507 where:

1st digit refers to BIOS maker as A = AMI, W = AWARD, and P = PHOENIX.

2nd - 5th digit refers to the model number.

6th digit refers to the chipset as I = Intel, N = nVidia, A = AMD and V = VIA.

7th - 8th digit refers to the customer as MS = all standard customers. V1.0 refers to the BIOS version.

122507 refers to the date this BIOS was released.

Control Keys

<↑>	Move to the previous item
<↓>	Move to the next item
<<->	Move to the item in the left hand
<->>	Move to the item in the right hand
<Enter>	Select the item
<Esc>	Jumps to the Exit menu or returns to the main menu from a submenu
<+ /PU>	Increase the numeric value or make changes
<- /PD>	Decrease the numeric value or make changes
<F6>	Load Optimized Defaults
<F10>	Save configuration changes and exit setup

Getting Help

After entering the Setup menu, the first menu you will see is the Main Menu.

Main Menu

The main menu lists the setup functions you can make changes to. You can use the arrow keys (↑↓) to select the item. The on-line description of the highlighted setup function is displayed at the bottom of the screen.

Sub-Menu

If you find a right pointer symbol (as shown in the right view) appears to the left of certain fields that means a sub-menu can be launched from this field. A sub-menu contains additional options for a field parameter. You can use arrow keys (↑↓) to highlight the field and press <Enter> to call up the sub-menu. Then you can use the control keys to enter values and move from field to field within a sub-menu. If you want to return to the main menu, just press the <Esc >.

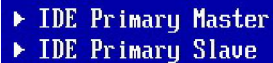

▶ IDE Primary Master
▶ IDE Primary Slave

General Help <F1>

The BIOS setup program provides a General Help screen. You can call up this screen from any menu by simply pressing <F1>. The Help screen lists the appropriate keys to use and the possible selections for the highlighted item. Press <Esc> to exit the Help screen.

The Main Menu

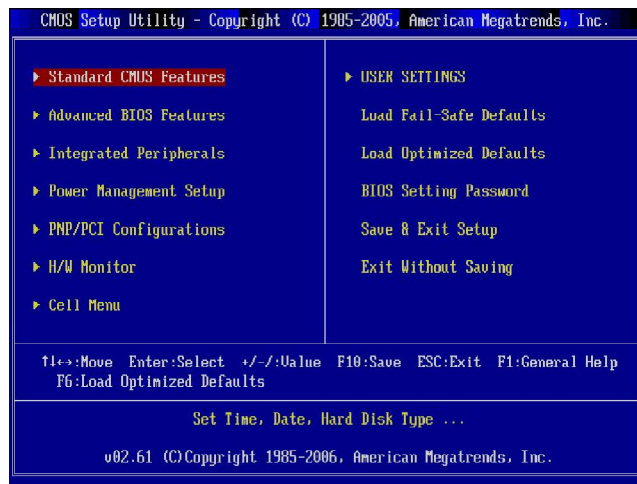

► **Standard CMOS Features**

Use this menu for basic system configurations, such as time, date etc.

► **Advanced BIOS Features**

Use this menu to setup the items of AMI® special enhanced features.

► **Integrated Peripherals**

Use this menu to specify your settings for integrated peripherals.

► **Power Management Setup**

Use this menu to specify your settings for power management.

► **PNP/PCI Configurations**

This entry appears if your system supports PnP/PCI.

► **H/W Monitor**

This entry shows your PC health status.

► **Cell Menu**

Use this menu to specify your settings for frequency/voltage control and overclocking.

► **USER SETTINGS**

Use this menu to save/ load your settings to/ from CMOS for BIOS.

BIOS Setup

▶ **Load Fail-Safe Defaults**

Use this menu to load the default values set by the BIOS vendor for stable system performance.

▶ **Load Optimized Defaults**

Use this menu to load the default values set by the mainboard manufacturer specifically for optimal performance of the mainboard.

▶ **BIOS Setting Password**

Use this menu to set the password for BIOS.

▶ **Save & Exit Setup**

Save changes to CMOS and exit setup.

▶ **Exit Without Saving**

Abandon all changes and exit setup.

Standard CMOS Features

The items in Standard CMOS Features Menu includes some basic setup items. Use the arrow keys to highlight the item and then use the <PgUp> or <PgDn> keys to select the value you want in each item.

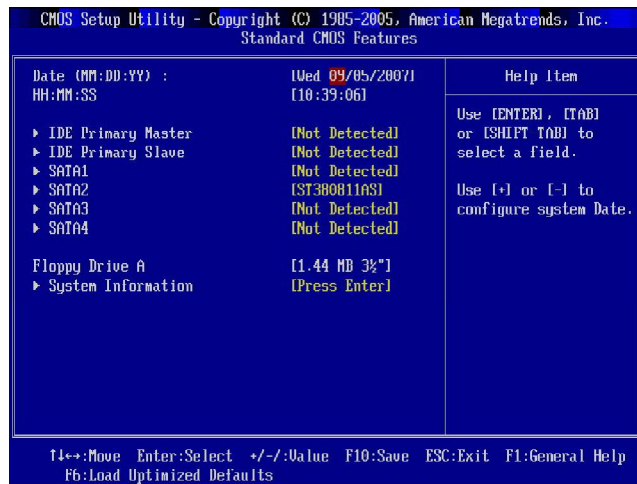

► Date (MM:DD:YY)

This allows you to set the system to the date that you want (usually the current date). The format is <day><month> <date> <year>.

day	Day of the week, from Sun to Sat, determined by BIOS. Read-only.
month	The month from Jan. through Dec.
date	The date from 1 to 31 can be keyed by numeric function keys.
year	The year can be adjusted by users.

► HH:MM:SS

This allows you to set the system time that you want (usually the current time). The time format is <hour> <minute> <second>.

► IDE Primary Master/ Slave, SATA1/ 2/ 3/ 4

Press <Enter> to enter the sub-menu, and the following screen appears.



Important

IDE Primary Master/ Slave, SATA1/ 2/ 3/ 4 are appearing when you connect the HD devices to the IDE/ SATA connector on the mainboard.

BIOS Setup



The screenshot shows the BIOS Setup Utility interface for the Primary IDE Master. The title bar reads 'CMOS Setup Utility - Copyright (C) 1985-2005, American Megatrends, Inc.' and the main title is 'Primary IDE Master'. The screen is divided into two columns. The left column lists configuration options: 'Device' (Hard Disk), 'Vendor' (ST3802110A), 'Size' (80.0GB), 'LBA/Large Mode' (Auto), 'DMA Mode' (Auto), and 'Hard Disk S.M.A.R.T.' (Auto). The right column is titled 'Help Item' and contains the following text: 'Disabled: Disables LBA Mode.', 'Auto: Enables LBA Mode if the device supports it and the device is not already formatted with LBA Mode disabled.'

Primary IDE Master	Help Item
Device :Hard Disk	Disabled: Disables LBA Mode. Auto: Enables LBA Mode if the device supports it and the device is not already formatted with LBA Mode disabled.
Vendor :ST3802110A	
Size :80.0GB	
LBA/Large Mode [Auto]	
DMA Mode [Auto]	
Hard Disk S.M.A.R.T. [Auto]	

► Device/ Vender/ Size

It will showing the device information that you connected to the IDE/SATA connector.

► LBA/Large Mode

This allows you to enable or disable the LBA Mode. Setting to Auto enables LBA mode if the device supports it and the devices is not already formatted with LBA mode disabled.

► DMA Mode

Select DMA Mode.

► Hard Disk S.M.A.R.T.

This allows you to activate the S.M.A.R.T. (Self-Monitoring Analysis & Reporting Technology) capability for the hard disks. S.M.A.R.T is a utility that monitors your disk status to predict hard disk failure. This gives you an opportunity to move data from a hard disk that is going to fail to a safe place before the hard disk becomes offline.

► Floppy A

This item allows you to set the type of floppy drives installed.

► System Information

Press <Enter> to enter the sub-menu, and the following screen appears.

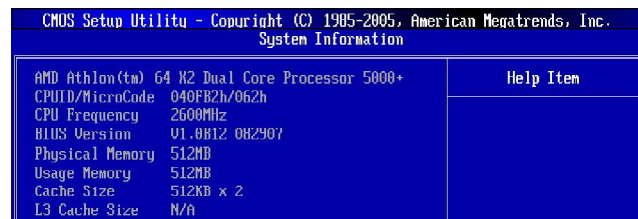

The screenshot shows the BIOS Setup Utility interface for System Information. The title bar reads 'CMOS Setup Utility - Copyright (C) 1985-2005, American Megatrends, Inc.' and the main title is 'System Information'. The screen is divided into two columns. The left column lists system information: 'AMD Athlon(tm) 64 X2 Dual Core Processor 5000+', 'CPUID/MicroCode 040FB2h/062h', 'CPU Frequency 2600MHz', 'BIOS Version 01.0012 082907', 'Physical Memory 512MB', 'Usage Memory 512MB', 'Cache Size 512KB x 2', and 'L3 Cache Size N/A'. The right column is titled 'Help Item' and is currently empty.

System Information	Help Item
AMD Athlon(tm) 64 X2 Dual Core Processor 5000+	
CPUID/MicroCode 040FB2h/062h	
CPU Frequency 2600MHz	
BIOS Version 01.0012 082907	
Physical Memory 512MB	
Usage Memory 512MB	
Cache Size 512KB x 2	
L3 Cache Size N/A	

► CPU Infromation/ BIOS Version/ Memory Information

These items show the CPU information, BIOS version and memory status of your system (read only).

Advanced BIOS Features

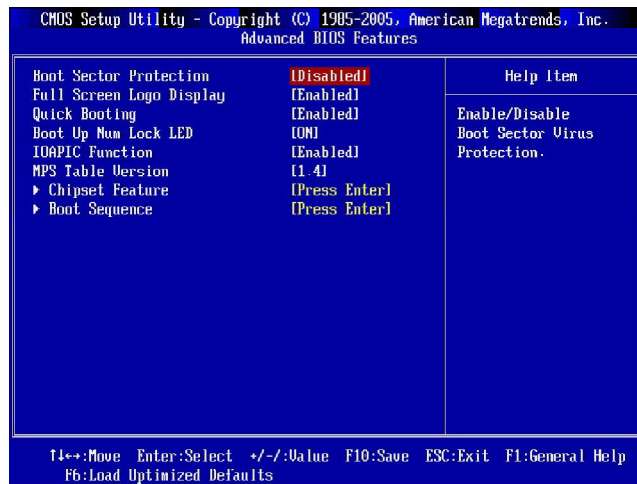

► Boot Sector Protection

When you enable this item and someone attempt to write data into this area, BIOS will show a warning message on screen and it will alarm beep.

► Full Screen LOGO Display

This item enables you to show the company logo on the bootup screen. Settings are:

- [Enabled] Shows a still image (logo) on the full screen at boot.
- [Disabled] Shows the POST messages at boot.

► Quick Booting

Setting the item to [Enabled] allows the system to boot within 5 seconds since it will skip some check items.

► Boot Up Num Lock LED

This setting is to set the Num Lock status when the system is powered on. Setting to [On] will turn on the Num Lock key when the system is powered on. Setting to [Off] will allow users to use the arrow keys on the numeric keypad.

► IOAPIC Function

This field is used to enable or disable the APIC (Advanced Programmable Interrupt Controller). Due to compliance with PC2001 design guide, the system is able to run in APIC mode. Enabling APIC mode will expand available IRQ resources for the system.

► **MPS Table Version**

This field allows you to select which MPS (Multi-Processor Specification) version to be used for the operating system. You need to select the MPS version supported by your operating system. To find out which version to use, consult the vendor of your operating system.

► **Chipset Feature**

Press <Enter> to enter the sub-menu and the following screen appears:



► **HPET**

The HPET (High Precision Event Timers) is a component that is part of the chipset. You can enable it, and it will provide you with the means to get to it via the various ACPI methods.

► **Port #02/03/11/12 High Speed Mode**

These items are used to define the PCIE 2.0 or PCIE 1.0 mode for PCIE x16 slots. Select "Disabled", all the PCIE x16 slots are compatible with PCIE 1.0.

► **Boot Sequence**

Press <Enter> to enter the sub-menu and the following screen appears:

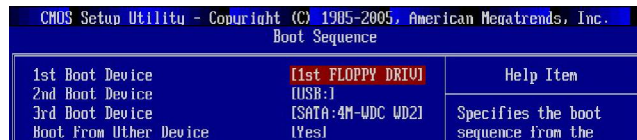

► **1st/2nd/3rd Boot Device**

The items allow you to set the first/ second/ third boot device where BIOS attempts to load the disk operating system.

► **Boot From Other Device**

Setting the option to [Yes] allows the system to try to boot from other device. if the system fails to boot from the 1st/ 2nd/ 3rd boot device.

Integrated Peripherals

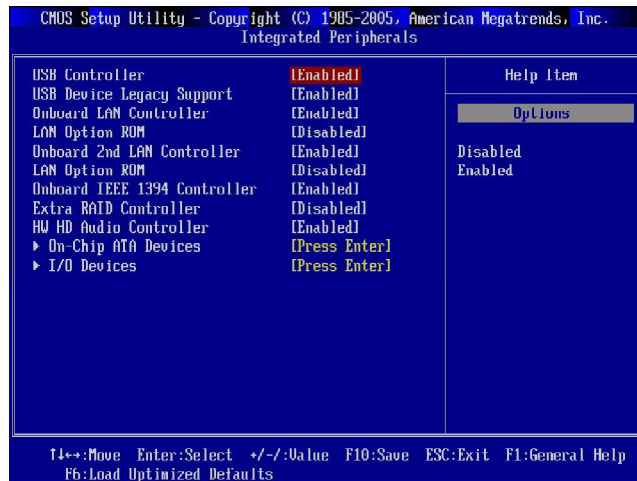

▶ USB Controller

This setting allows you to enable/disable the onboard USB 1.1/ 2.0 controller.

▶ USB Device Legacy Support

Select [Enabled] if you need to use a USB-interfaced device in the operating system.

▶ Onboard LAN Controller

This setting allows you to enable/disable the onboard LAN controller.

▶ LAN Option ROM

This item is used to decide whether to invoke the Boot ROM of the onboard LAN.

▶ Onboard 2nd LAN Controller

This item is used to enable/disable the onboard 2nd LAN controller.

▶ LAN Option ROM

This item is used to decide whether to invoke the Boot ROM of the 2nd LAN controller.

▶ Onboard IEEE1394 Controller

This item allows you to enable/disable the onboard IEEE1394 controller.

► **Extra RAID Controller (for Promise RAID)**

This item allows you to enable/disable the onboard extra RAID controller.



Important

If you intend to use a extra RAID function card, you have to disable the "Extra RAID Controller" item.

► **HW HD Audio Controller**

This setting is used to enable/disable the HD audio controller.

► **On-Chip ATA Devices**

Press <Enter> to enter the sub-menu:



► **PCI IDE BusMaster**

This item allows you to enable/ disable BIOS to used PCI busmastering for reading/ writing to IDE drives.

► **On-Chip SATA Controller (for SB600 RAID)**

These items allow users to enable or disable the SATA controller.

► **SATA Mode (for SB600 RAID)**

This item is used to enable/disable the RAID function for SATA devices.

► **I/O Devices**

Press <Enter> to enter the sub-menu:



► **COM Port 1**

This item specifies the base I/O port addresses of the onboard Serial Port.

Power Management Setup

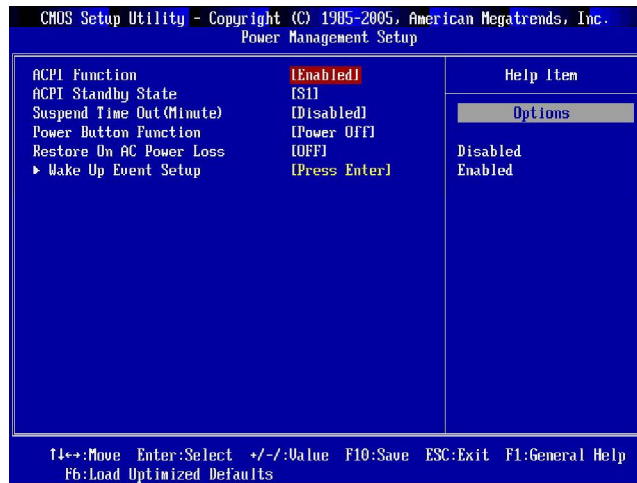

Important

S3-related functions described in this section are available only when your BIOS supports S3 sleep mode.

▶ ACPI Function

This item is to activate the ACPI (Advanced Configuration and Power Management Interface) Function. If your operating system is ACPI-aware, such as Windows 98SE/2000/ME/XP, select [Enabled].

▶ ACPI Standby State

This item specifies the power saving modes for ACPI function. If your operating system supports ACPI, such as Windows 2000/XP, you can choose to enter the Standby mode in S1(POS) or S3(STR) fashion through the setting of this field. Settings are:

- [S1] The S1 sleep mode is a low power state. In this state, no system context is lost (CPU or chipset) and hardware maintains all system context.
- [S3] The S3 sleep mode is a lower power state where the information of system configuration and open applications/files is saved to main memory that remains powered while most other hardware components turn off to save energy. The information stored in memory will be used to restore the system when a "wake up" event occurs.

► **Suspend Time Out (Minute)**

If system activity is not detected for the length of time specified in this field, all devices except CPU will be shut off.

► **Power Button Function**

This feature sets the function of the power button. Settings are:

- [Power On/ Off] The power button functions as normal power on/ off button.
- [Suspend] When you press the power button, the computer enters the suspend/sleep mode, but if the button is pressed for more than four seconds, the computer is turned off.

► **Restore On AC Power Loss**

This item specifies whether your system will reboot after a power failure or interrupt occurs. Settings are:

- [Off] Always leaves the computer in the power off state.
- [On] Always leaves the computer in the power on state.
- [Last State] Restores the system to the status before power failure or interrupt occurred.

► **Wake Up Event Setup**

Press <Enter> to enter the sub-menu:



► **Resume From S3 By USB Device**

The item allows the activity of the USB device to wake up the system from S3 (Suspend to RAM) sleep state.

► **Resume From S3 By PS/2 Keyboard**

This controls how the PS/2 keyboard is able to power on the system. If you choose *Specific Key*, the power button on the case will not function anymore and you must type the password to power on the system.

► **Resume from S3 By PS/2 Mouse**

This setting determines whether the system will be awakened from what power saving modes when input signal of the PS/2 mouse is detected.

► **Resume by PCI Device (PME#)**

When set to [Enabled], the feature allows your system to be awakened from the power saving modes through any event on PME (Power Management Event).

MS-7376 Mainboard**▶ Resume by PCIE Device**

When set to [Enabled], the feature allows your system to be awakened from the power saving modes through any event on PCIE device.

▶ Resume by RTC Alarm

The field is used to enable or disable the feature of booting up the system on a scheduled time/date.

PNP/PCI Configurations

This section describes configuring the PCI bus system and PnP (Plug & Play) feature. PCI, or **Peripheral Component Interconnect**, is a system which allows I/O devices to operate at speeds nearing the speed the CPU itself uses when communicating with its special components. This section covers some very technical items and it is strongly recommended that only experienced users should make any changes to the default settings.

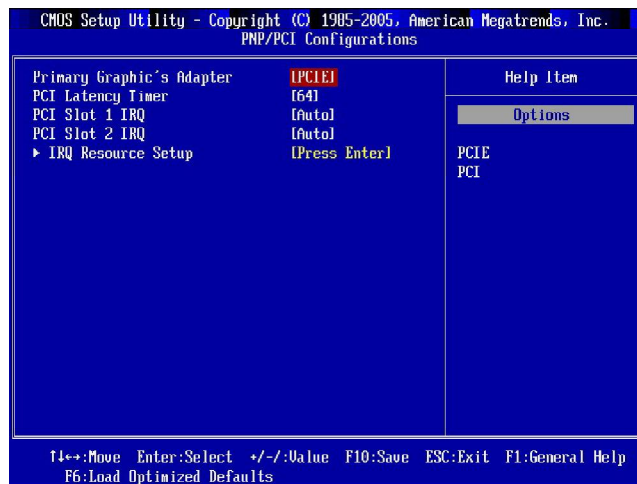

▶ Primary Graphic's Adapter

This setting specifies which graphic card is your primary graphics adapter.

▶ PCI Latency Timer

This item controls how long each PCI device can hold the bus before another takes over. When set to higher values, every PCI device can conduct transactions for a longer time and thus improve the effective PCI bandwidth. For better PCI performance, you should set the item to higher values.

▶ PCI Slot 1/2 IRQ

This setting specifies IRQ for PCI devices.

► **IRQ Resource Setup**

Press <Enter> to enter the sub-menu and the following screen appears.



► **IRQ 3/4/5/7/9/10/11/14/15**

These items specify the bus where the specified IRQ line is used.

The settings determine if AMIBIOS should remove an IRQ from the pool of available IRQs passed to devices that are configurable by the system BIOS. The available IRQ pool is determined by reading the ESCD NVRAM. If more IRQs must be removed from the IRQ pool, the end user can use these settings to reserve the IRQ by assigning an [Reserved] setting to it. Onboard I/O is configured by AMIBIOS. All IRQs used by onboard I/O are configured as [Available]. If all IRQs are set to [Reserved], and IRQ 14/15 are allocated to the onboard PCI IDE, IRQ 9 will still be available for PCI and PnP devices.



Important

IRQ (Interrupt Request) lines are system resources allocated to I/O devices. When an I/O device needs to gain attention of the operating system, it signals this by causing an IRQ to occur. After receiving the signal, when the operating system is ready, the system will interrupt itself and perform the service required by the I/O device.

H/W Monitor

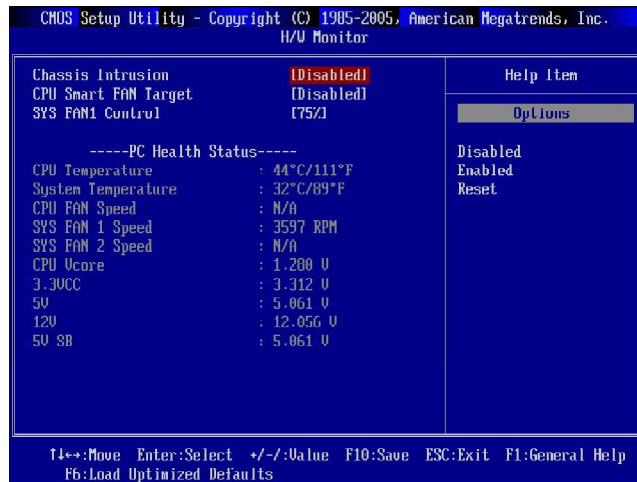

► Chassis Intrusion

The field enables or disables the feature of recording the chassis intrusion status and issuing a warning message if the chassis is once opened. To clear the warning message, set the field to [Reset]. The setting of the field will automatically return to [Enabled] later.

► CPU Smart FAN Target

The mainboard provides the Smart Fan function which can control the CPU fan speed automatically depending on the current temperature to keep it within a specific range. You can select a fan target value here. If the current CPU fan temperature reaches the target value, the smart fan function will be activated. It provides several sections to speed up for cooling down automatically.

► SYS FAN1 Control

This item allows users to select how percentage of speed for the SYS FAN1.

► PC Health Status

► CPU/ System Temperature, CPU FAN/ SYS FAN1/ SYS FAN2 Speed, CPU Vcore, 3.3V, 5V, 12V, 5V SB

These items display the current status of all of the monitored hardware devices/ components such as CPU voltage, temperatures and all fans' speeds.

Cell Menu

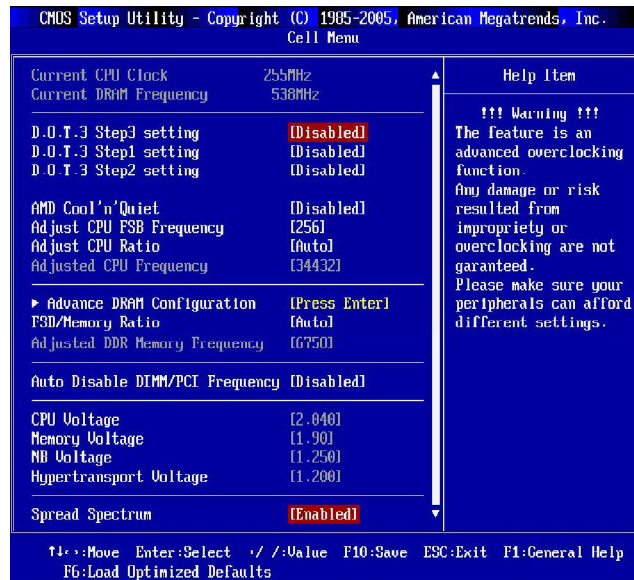

Important

Change these settings only if you are familiar with the chipset.

► **Current CPU Clock/ DRAM Frequency**

These items show the current clocks of CPU and Memory frequency. Read-only.

► **D.O.T.3 Step 3/ 1/ 2 setting**

The D.O.T.3 has 3 steps to overclock the CPU/ PCIE, you can set the overclocking percentage for each step. When the CPU loading reaches to 20%, the CPU/ PCIE frequencies will overclock according the setting of step1. When the CPU loading reaches to 50%, the CPU/ PCIE frequencies will overclock according the setting of step2. When the CPU loading reaches to 80%, the CPU/ PCIE frequencies will overclock according the setting of step3.

► **AMD Cool'n'Quiet**

The Cool'n' Quiet technology can effectively and dynamically lower CPU speed and power consumption.



Important

To ensure that Cool'n'Quiet function is activated and will be working properly, it is required to double confirm that:

1. Run BIOS Setup, and select **Cell Menu**. Under **Cell Menu**, find **AMD Cool'n'Quiet**, and set this item to "Enable."
2. Enter Windows, and select [Start]->[Settings]->[Control Panel]->[Power Options]. Enter **Power Options Properties** tag, and select **Minimal Power Management** under **Power schemes**.

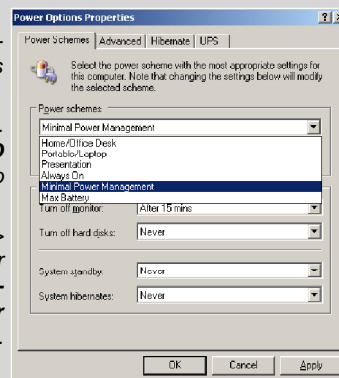

► **Adjust CPU FSB Frequency**

This item allows you to set the CPU FSB frequency (in MHz).

► **Adjust CPU Ratio**

This item allows you to set the CPU ratio.

► **Adjusted CPU Frequency**

It shows the adjusted CPU frequency (FSB x Ratio). Read-only.

► **Advance DRAM Configuration**

Press <Enter> to enter the sub-menu and the following screen appears.



► **DRAM Timing Mode**

Setting to [Auto] enables DRAM CAS# Latency automatically to be determined by BIOS based on the configurations on the SPD (Serial Presence Detect) EEPROM on the DRAM module.

► **Bank Interleaving**

This field selects 2-bank or 4-bank interleave for the installed SDRAM. Disable the function if 16MB SDRAM is installed.

► **1T/2T Memory Timing**

This field controls the SDRAM command rate. Selecting [1T] makes SDRAM signal controller to run at 1T (T=clock cycles) rate. Selecting [2T] makes SDRAM signal controller run at 2T rate.

► **Memory Hole at 15M Addr.**

You can reserve this area of system memory for ISA adapter ROM. When this area is reserved, it cannot be cached. The user information of peripherals that need to use this area of system memory usually discusses their memory requirements.

► **Unganged Mode support**

The Unganged mode can split the available bandwidth into two distinct channels, and this item is used to disable/ enable the ungang mode.

► **FSB/Memory Ratio**

This item will allow you to adjust the FSB/Ratio of the memory.

► **Adjusted DDR Memory Frequency**

It shows the adjusted DDR Memory frequency. Read-only.

► **Auto Disable DIMM/PCI Frequency**

When set to [Enabled], the system will remove (turn off) clocks from empty DIMM and PCI slots to minimize the electromagnetic interference (EMI).

► **CPU Voltage / Memory Voltage / NB Voltage / Hypertransport Voltage**

These items display the power status of CPU, Memory, FSB and chipset. Read-only.

► **Spread Spectrum**

When the motherboard's clock generator pulses, the extreme values (spikes) of the pulses create EMI (Electromagnetic Interference). The Spread Spectrum function reduces the EMI generated by modulating the pulses so that the spikes of the pulses are reduced to flatter curves. If you do not have any EMI problem, leave the setting at Disabled for optimal system stability and performance. But if you are plagued by EMI, set to Enabled for EMI reduction. Remember to disable Spread Spectrum if you are overclocking because even a slight jitter can introduce a temporary boost in clock speed which may just cause your overclocked processor to lock up.



Important

1. If you do not have any EMI problem, leave the setting at [Disabled] for optimal system stability and performance. But if you are plagued by EMI, select the value of Spread Spectrum for EMI reduction.
2. The greater the Spread Spectrum value is, the greater the EMI is reduced, and the system will become less stable. For the most suitable Spread Spectrum value, please consult your local EMI regulation.
3. Remember to disable Spread Spectrum if you are overclocking because even a slight jitter can introduce a temporary boost in clock speed which may just cause your overclocked processor to lock up.

USER SETTINGS

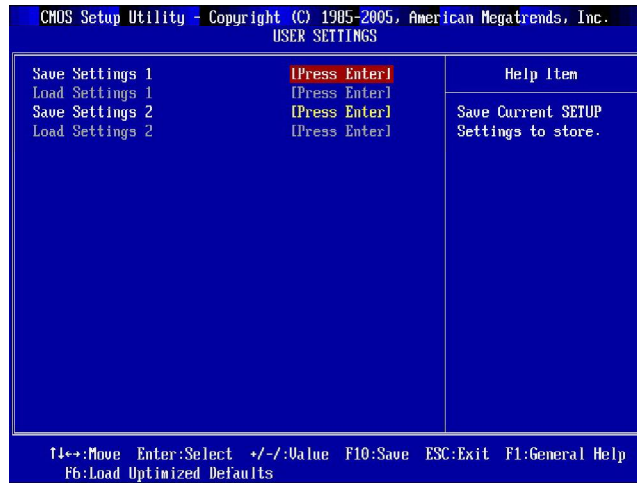

► Save Settings 1/ 2

These items are used to save the settings set by yourself to CMOS.

► Load Settings 1/ 2

These items are available after you save your settings in **Save Settings 1/ 2** items , and are used to load the settings from CMOS.

Load Fail-Safe/ Optimized Defaults

The two options on the main menu allow users to restore all of the BIOS settings to the default Fail-Safe or Optimized values. The Optimized Defaults are the default values set by the mainboard manufacturer specifically for optimal performance of the mainboard. The Fail-Safe Defaults are the default values set by the BIOS vendor for stable system performance.

When you select Load Fail-Safe Defaults, a message as below appears:

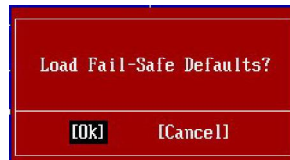

Selecting Ok and pressing Y loads the BIOS default values for the most stable, minimal system performance.

When you select Load Optimized Defaults, a message as below appears:



Selecting Ok and pressing Y loads the default factory settings for optimal system performance.

BIOS Setting Password

When you select this function, a message as below will appear on the screen:



Type the password, up to six characters in length, and press <Enter>. The password typed now will replace any previously set password from CMOS memory. You will be prompted to confirm the password. Retype the password and press <Enter>. You may also press <Esc> to abort the selection and not enter a password.

To clear a set password, just press <Enter> when you are prompted to enter the password. A message will show up confirming the password will be disabled. Once the password is disabled, the system will boot and you can enter Setup without entering any password.

When a password has been set, you will be prompted to enter it every time you try to enter Setup. This prevents an unauthorized person from changing any part of your system configuration.

Appendix A

Realtek Audio

The Realtek Audio provides 10-channel DAC that simultaneously supports 7.1 sound playback and 2 channels (*multiple streaming) of independent stereo sound output through the Front-Out-Left and Front-Out-Right channels. (* Multiple streaming function is for ALC888 only, the ALC888T supports 7.1 channel only.)

Installing the Realtek HD Audio Driver

You need to install the driver for Realtek Audio codec to function properly before you can get access to 2-, 4-, 6-, 8- channel or 7.1+2 channel (for ALC888 only) audio operations. Follow the procedures described below to install the drivers for different operating systems.

Installation for Windows 2000/XP/Vista

For Windows® 2000, you must install Windows® 2000 Service Pack4 or later before installing the driver. For Windows® XP, you must install Windows® XP Service Pack1 or later before installing the driver.

The following illustrations are based on Windows® XP environment and could look slightly different if you install the drivers in different operating systems.

1. Insert the application CD into the CD-ROM drive. The setup screen will automatically appear.
2. Click **Realtek HD Audio Driver**.



Important

The HD Audio Configuration software utility is under continuous update to enhance audio applications. Hence, the program screens shown here in this section may be slightly different from the latest software utility and shall be held for reference only.

Realtek Audio

3. Click **Next** to install the Realtek High Definition Audio Driver.

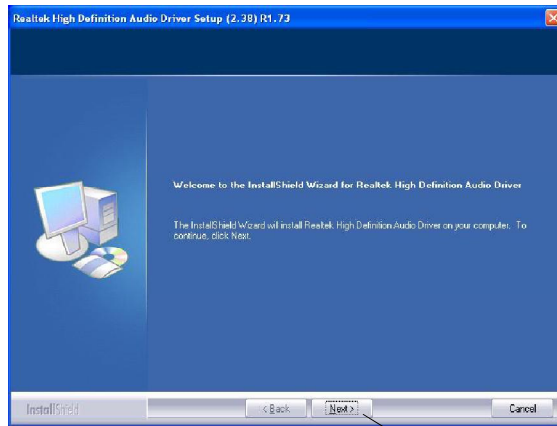

Click here

4. Click **Finish** to restart the system.

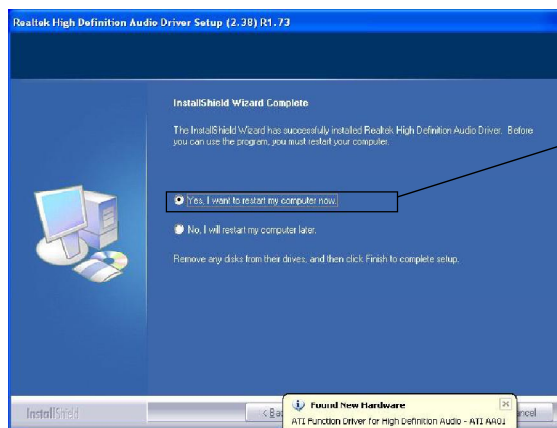

Select this option

Software Configuration

After installing the audio driver, you are able to use the 2-, 4-, 6- or 8- channel audio feature now. Click the audio icon  from the system tray at the lower-right corner of the screen to activate the **HD Audio Configuration**. It is also available to enable the audio driver by clicking the **Realtek HD Audio Manager** from the **Control Panel**.



Double click

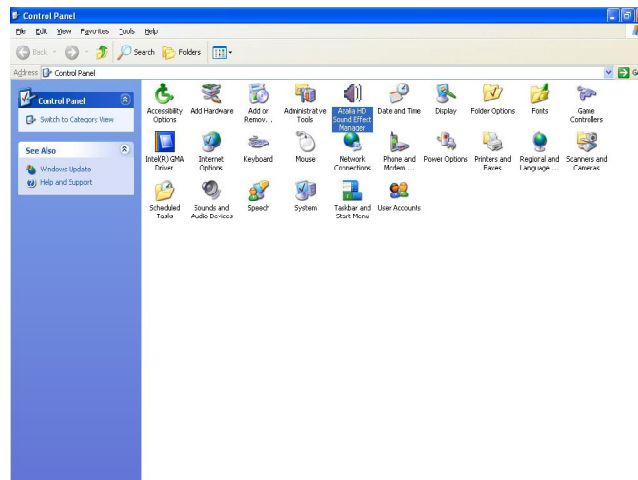

Sound Effect

Here you can select a sound effect you like from the **Environment** list.



Environment Simulation

You will be able to enjoy different sound experience by pulling down the arrow, totally 23 kinds of sound effect will be shown for selection. Realtek HD Audio Sound Manager also provides five popular settings “Stone Corridor”, “Bathroom”, “Sewer pipe”, “Arena” and “Audio Corridor” for quick enjoyment.

You may choose the provided sound effects, and the equalizer will adjust automatically. If you like, you may also load an equalizer setting or make a new equalizer setting to save as a new one by using the “**Load EQ Setting**” and “**Save Preset**” button, click “**Reset EQ Setting**” button to use the default value, or click “**Delete EQ Setting**” button to remove a preset EQ setting.

There are also other pre-set equalizer models for you to choose by clicking “**Others**” under the **Equalizer** part.

Equalizer Selection

Equalizer frees users from default settings; users may create their own preferred settings by utilizing this tool.

10 bands of equalizer, ranging from 100Hz to 16KHz.

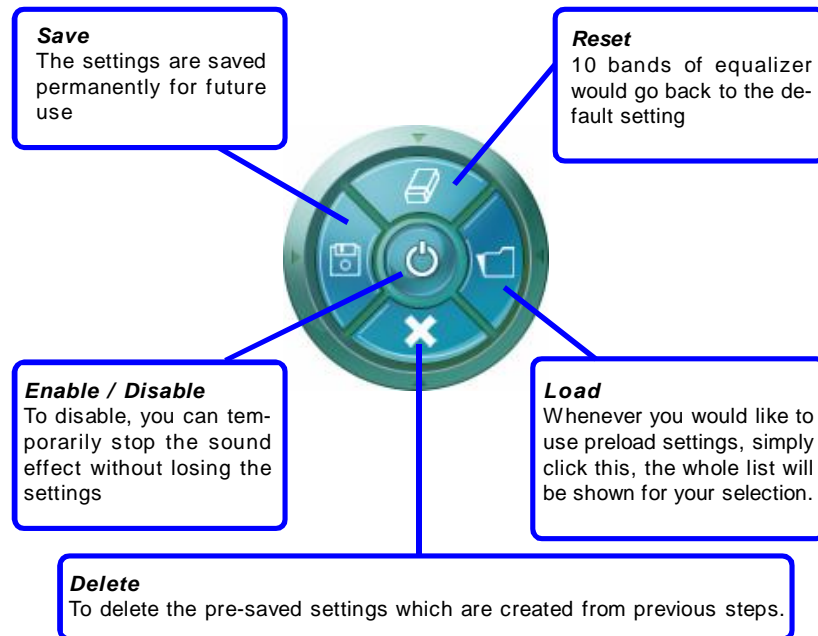
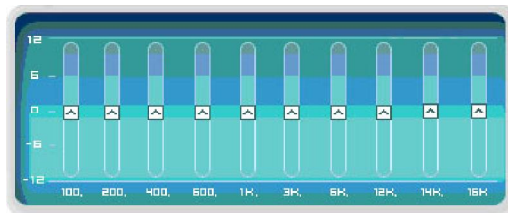

Frequently Used Equalizer Setting

Realtek recognizes the needs that you might have. By leveraging our long experience at audio field, Realtek HD Audio Sound Manager provides you certain optimized equalizer settings that are frequently used for your quick enjoyment.

[How to Use It]

Other than the buttons "Pop" "Live" "Club" & "Rock" shown on the page, to pull down the arrow in "Others", you will find more optimized settings available to you.

Karaoke Mode

Karaoke mode brings Karaoke fun back home. Simply using the music you usually play, Karaoke mode can help you eliminate the vocal of the song or adjust the key to accommodate your range.

- 1.Vocal Cancellation: Single click on "Voice Cancellation", the vocal of the song would be eliminated, while the background music is still in place, and you can be that singer!
- 2.Key Adjustment: Using "Up / Down Arrow" to find a key which better fits your vocal range.



Mixer

In the **Mixer** part, you may adjust the volumes of the rear and front panels individually.

1. Adjust Volume

You can adjust the volume of the speakers that you plugged in front or rear panel by select the **Realtek HD Audio rear output** or **Realtek HD Audio front output** items.



Important

*Before set up, please make sure the playback devices are well plugged in the jacks on the rear or front panel. The **Realtek HD Audio front output** item will appear after you plugging the speakers into the jacks on the front panel.*

2. Multi-Stream Function (for ALC888 only)

ALC888 supports an outstanding feature called Multi-Stream, which means you may play different audio sources simultaneously and let them output respectively from the indicated rear panel or front panel. This feature is very helpful when 2 people are using the same computer together for different purposes.

Click the  button and the Mixer **ToolBox** menu will appear. Then check the **Enable playback multi-streaming** and click **OK** to save the setup.



Important

*If you use **AC97 front panel**, the device have to be plugged into the jacks on the panel before enable the multi-stream function.*

Realtek Audio

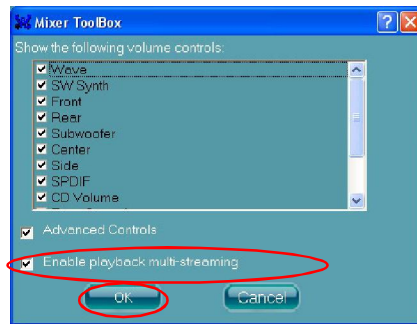

When you are playing the first audio source (for example: use Windows Media Player to play DVD/VCD), the output will be played from the rear panel, which is the default setting.

Then you **must** select the **Realtek HD Audio front output** from the scroll list **first**, and use a different program to play the second audio source (for example: use Winamp to play MP3 files). You will find that the second audio source (MP3 music) will come out from the Line-Out audio jack of Front Panel.



3. Playback control



Playback device
This function is to let you freely decide which ports to output the sound. And this is essential when multi-streaming playback enabled.
- Realtek HD Audio Rear Output
- Realtek HD Audio Front Output

Mute

You may choose to mute single or multiple volume controls or to completely mute sound output.

Tool

- Show the following volume controls

This is to let you freely decide which volume control items to be displayed.

- Advanced controls
- Enable playback multi-streaming

With this function, you will be able to have an audio chat with your friends via headphone (stream 1 from front panel) while still have music (stream 2 from back panel) in play. At any given period, you can have maximum 2 streams operating simultaneously.



4. Recording control



Mute

You may choose to mute single or multiple volume controls or to completely mute sound input.

Tool

- Show the following volume controls

This is to let you freely decide which volume control items to be displayed.

- Enable recording multi-streaming

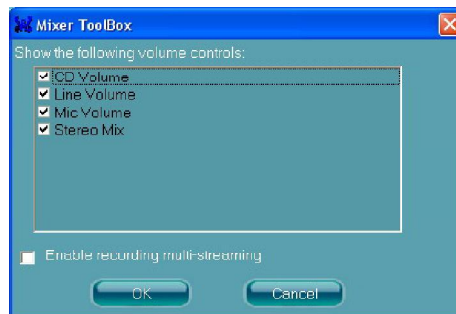

Important

Realtek Audio allows you to record the CD, Line, Mic and Stereo Mix channels simultaneously, frees you from mixing efforts. At any given period, you may choose 1 of the following 4 channels to record.

Audio I/O

In this tab, you can easily configure your multi-channel audio function and speakers. You can choose a desired multi-channel operation here.

- a. **Headphone** for the common headphone
- b. **2CH Speaker** for Stereo-Speaker Output
- c. **4CH Speaker** for 4-Speaker Output
- d. **6CH Speaker** for 5.1-Speaker Output
- e. **8CH Speaker** for 7.1-Speaker Output



Speaker Configuration:

1. Plug the speakers in the corresponding jack.
2. Dialogue "connected device" will pop up for your selection. Please select the device you have plugged in.
 - If the device is being plugged into the correct jack, you will be able to find the icon beside the jack changed to the one that is same as your device.
 - If not correct, Realtek HD Audio Manager will guide you to plug the device into the correct jack.

Connector Settings

Click  to access connector settings.



Disable front panel jack detection (option)

Find no function on front panel jacks? Please check if front jacks on your system are so-called AC'97 jacks. If so, please check this item to disable front panel jack detection.

Mute rear panel output when front headphone plugged in.

Enable auto popup dialogue, when device has been plugged in

Once this item checked, the dialog "Connected device" would automatically pop up when device plugged in.

S/PDIF

Short for Sony/Philips Digital Interface, a standard audio file transfer format. S/PDIF allows the transfer of digital audio signals from one device to another without having to be converted first to an analog format. Maintaining the viability of a digital signal prevents the quality of the signal from degrading when it is converted to analog.

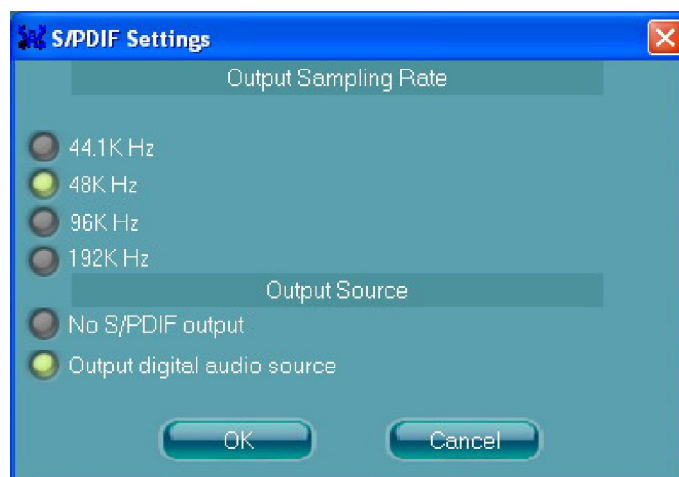

Output Sampling Rate

- 44.1KHz: This is recommend while playing CD.
- 48KHz: This is recommended while playing DVD or Dolby.
- 96KHz: This is recommended while playing DVD-Audio.
- 192KHz: This is recommended while playing High quality Audio.

Output Source

Output digital audio source: The digital audio format (such as .wav, .mp3,.midi etc) will come out through S/PDIF-Out.

Test Speakers

You can select the speaker by clicking it to test its functionality. The one you select will light up and make testing sound. If any speaker fails to make sound, then check whether the cable is inserted firmly to the connector or replace the bad speakers with good ones. Or you may click the **auto test**  button to test the sounds of each speaker automatically.

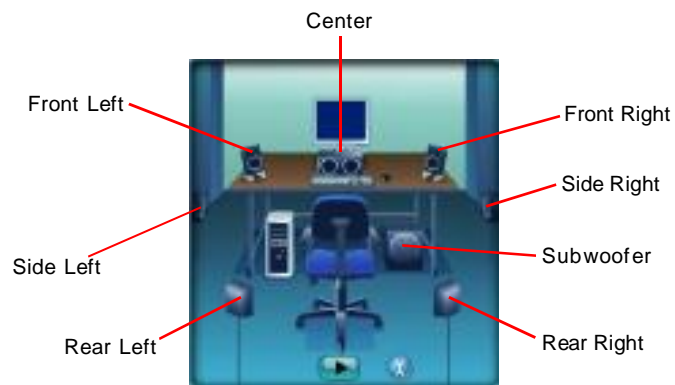

Microphone

In this tab you may set the function of the microphone. Select the **Noise Suppression** to remove the possible noise during recording, or select **Acoustic Echo Cancellation** to cancel the acoustic echo during recording.

Acoustic Echo Cancellation prevents playback sound from being recorded by microphone together with your sound. For example, you might have chance to use VOIP function through Internet with your friends. The voice of your friend will come out from speakers (playback). However, the voice of your friend might also be recorded into your microphone then go back to your friend through Internet. In that case, your friend will hear his/her own voice again. With AEC(Acoustic Echo Cancellation) enabled at your side, your friend can enjoy the benefit with less echo.



3D Audio Demo

In this tab you may adjust your 3D positional audio before playing 3D audio applications like gaming. You may also select different environment to choose the most suitable environment you like.



Information

In this tab it provides some information about this HD Audio Configuration utility, including Audio Driver Version, DirectX Version, Audio Controller & Audio Codec. You may also select the language of this utility by choosing from the **Language** list.



Also there is a selection **Show icon in system tray**. Switch it on and an icon  will show in the system tray. Right-click on the icon and the **Audio Accessories** dialogue box will appear which provides several multimedia features for you to take advantage of.



Hardware Setup

Connecting the Speakers

When you have set the Multi-Channel Audio Function mode properly in the software utility, connect your speakers to the correct phone jacks in accordance with the setting in software utility.

n 2-Channel Mode for Stereo-Speaker Output

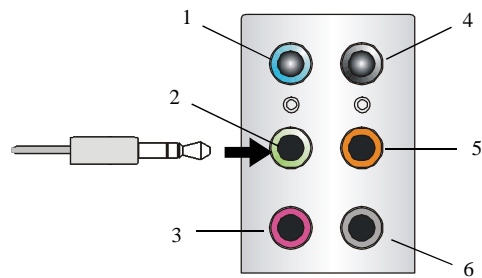

- 1 Line In
- 2 Line Out (*Front channels*)
- 3 MIC
- 4 No function
- 5 No function
- 6 No function

n 4-Channel Mode for 4-Speaker Output

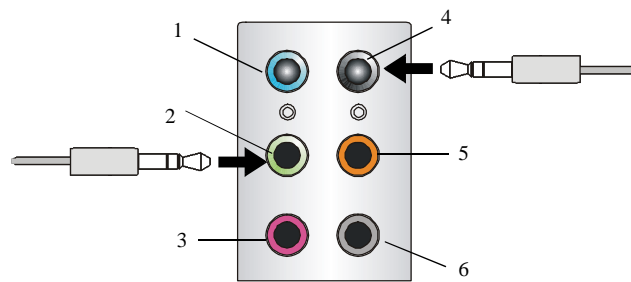

4-Channel Analog Audio Output

- 1 Line In
- 2 Line Out (*Front channels*)
- 3 MIC
- 4 Line Out (*Rear channels*)
- 5 No function
- 6 No function

n 6-Channel Mode for 6-Speaker Output

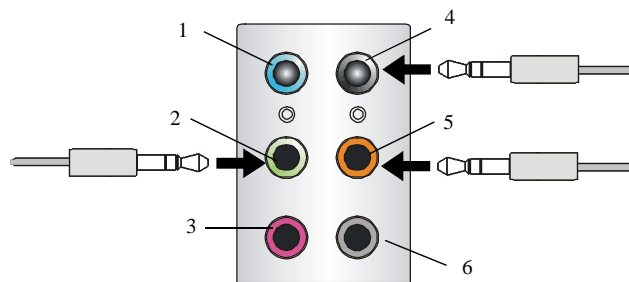

6-Channel Analog Audio Output

- 1 Line In
- 2 Line Out (*Front channels*)
- 3 MIC
- 4 Line Out (*Rear channels*)
- 5 Line Out (*Center and Subwoofer channel*)
- 6 No function

n 8-Channel Mode for 8-Speaker Output

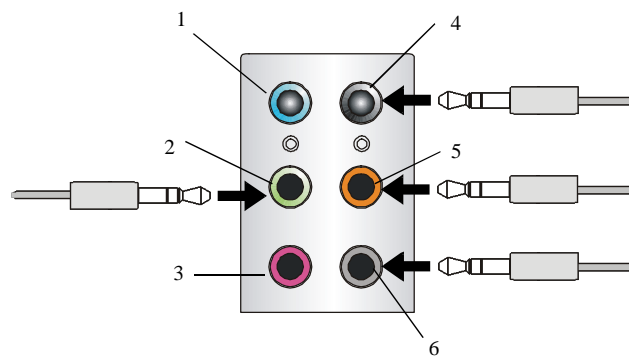

8-Channel Analog Audio Output

- 1 Line In
- 2 Line Out (Front channels)
- 3 MIC
- 4 Line Out (Rear channels)
- 5 Line Out (Center and Subwoofer channel)
- 6 Line Out (Side channels)



Important

To enable 7.1 channel audio-out function on Vista operating system, you have to install the Realtek Audio Driver. Or, the mainboard will support 5.1 channel audio-out only.

Appendix B

Dual Core Center

Dual CoreCenter, the most useful and powerful utility that MSI has spent much research and efforts to develop, helps users to monitor or configure the hardware status of MSI Mainboard & MSI Graphics card in windows, such as CPU/GPU clock, voltage, fan speed and temperature.

Before you install the Dual CoreCenter, please make sure the system has meet the following requirements:

1. Intel Pentium4 / Celeron, AMD Athlon XP/ Sempron or newer CPU.
2. 256MB system memory.
3. CD-ROM drive for software installation.
4. Operation system: Windows XP.
5. DotNet Frame Work 2.0

Activating Dual Core Center

Once you have your Dual Core Center installed (locate the setup source file in the setup CD accompanying with your mainboard, path: **Utility --> MSI Utility --> Dual Core Center**), it will have an icon  in the system tray, a short cut icon on the desktop, and a short cut path in your "Start-up" menu. You may double-click on each icon to enable Dual Core Center.



short-cut icon in the system tray

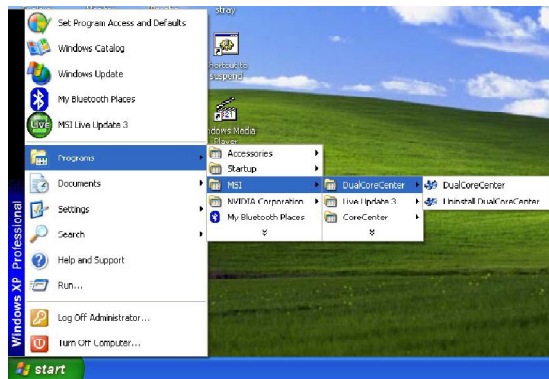

short-cut path in the start-up menu
(path: Start-->Programs-->MSI-->DualCoreCenter-->DualCoreCenter)

Main

Before using this utility, we have to remind you: only when installing the MSI V044 (V044 has to install with the version 8.26 or newer driver)/ V046 or V060 graphics card can activate the full function of this utility. If you install a graphics card of other brand, only hardware status of the MSI mainboard would be available.

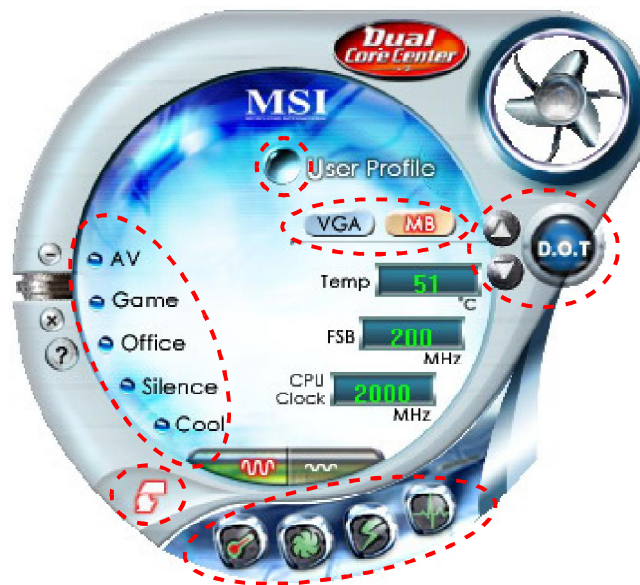

Introduction:

Click each button appearing above to enter sub-menu to make further configuration or to execute the function.

MB

Click MB button to read current CPU temperature, FSB and CPU clock of mainboard will show below.

VGA

Click VGA button to read current GPU temperature, GPU clock and memory clock of graphics card will show below.

DOT

Click DOT button to enable or disable the Dynamic Overclocking Technology.

MS-7376 Mainboard

AV/ Game/ Office/ Silence/ Cool

MSI provides five common settings for different environments. The settings had been set to optimal values to reach better performance in each environment. Click the button you need.



Important

Before clicking the AV/ Game/ Office/ Silence or Cool button, select Smooth mode or Sharp mode to decide whether you want the system to reach the optimal values smoothly or quickly.

Sharp mode  **Smooth mode**

Clock

In this sub-menu, you can adjust and monitor the clocks of MB and graphics card.

Voltage

In this sub-menu, you can adjust and monitor the voltages of MB and graphics card.

FAN Speed

In this sub-menu, you can adjust and monitor the fan speeds of MB and graphics card.

Temperature

In this sub-menu, you can monitor the temperatures of MB and graphics card.

User Profile

In this sub-menu, you can set the values of clock, voltage and fan speed by your need and save them in a profile. You can save 3 profiles for further use.





Important

Click on the icon , the clock, voltage, fan, and temperature buttons will appear beside the icon.



DOT (Dynamic OverClocking)

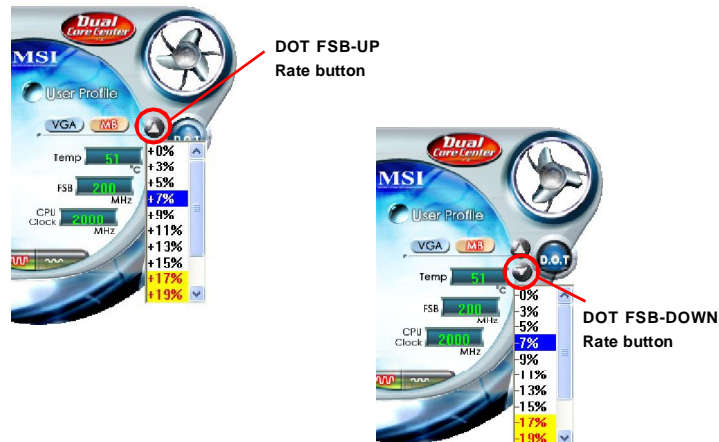

Dynamic Overclocking Technology is an automatic overclocking function, included in the MSI™'s newly developed Dual CoreCenter Technology. It is designed to detect the loading of CPU/ GPU while running programs, and to over-clock automatically. When the motherboard detects that the loading of CPU is exceed the default threshold for a time, it will speed up the CPU and fan automatically to make the system run smoother and faster. When the graphics card detects that the loading of GPU is exceed the default threshold for a time, it will speed up the GPU, memory, fan and voltage automatically to make the system run smoother and faster. When the CPU/ GPU is temporarily suspending or staying in low loading balance, it will restore the default settings instead. Usually the Dynamic Overclocking Technology will be powered only when users' PC runs huge amount of data, like 3D games or video process, and the motherboard/ graphicd card need to be boosted up to enhance the overall performance. There will be several selections when you click the DOT rate button (include increase rate  and decrease rate  rate buttons), to select the DOT level, then you have to click the DOT button  to apply the DOT function.



Important

Even though the Dynamic Overclocking Technology is more stable than manual overclocking, basically, it is still risky. We suggest user to make sure that your CPU can afford to overclock regularly first. If you find the PC appears to be unstable or reboot incidentally, it's better to lower the level of overclocking options. By the way, if you need to conduct overclocking manually, please do not to apply the DOT function.

Clock

In the **Clock** sub-menu, you can see clock status (including FSB/ CPU clock of mainboard and GPU/ memory clock of graphics card) of your system. And you can select desired value for overclocking. There will be several items for you to select for overclocking after you click  button. You can click the plus sign button  to increase the clock, or click the minus sign button  to decrease the clock. And finally, click the Apply button to apply the values adjusted. If you do not want to apply the adjustments, click the Cancel button to cancel. Or click the Default button to restore the default values.

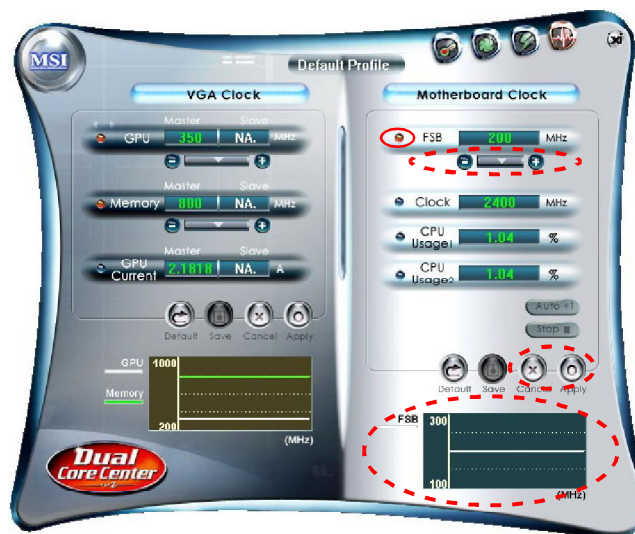



On the underside, it shows the graphs of the clocks. Only the curves of the item which the button is lit up with red color will be shown.



Important

*In the user profile, clicking the **Save** button can save the changes to it. In the default profile, the Save button is not available.*

Voltage

In the **Voltage** sub-menu, you can see voltage status (including Vcore, memory, GPU voltage... etc.) of your system, and you can select desired value for overclocking. It will show several items to select for overclocking after you click the  button. You can click the plus sign button  to increase the voltage, or click the minus sign button  to decrease. And finally, click the Apply button to apply the adjustments. If you do not want to apply the adjustments, click the Cancel button to cancel. Or click the Default button to restore the default values.





On the underside, it shows the graphs of the voltages. Only the curves of the item which the button is lit up with red color will be shown.



Important

*In the user profile, clicking the **Save** button can save the changes to it. In the default profile, the Save button is not available.*

FAN Speed

In the **FAN Speed** sub-menu, you can read fan status of your system. Select higher speed for better cooling effect. There are several sections for you to change the fan speed to a section after clicking  button. Click the plus sign button  to increase the fan speed to a section, or click the minus sign button  to decrease. Or click the Default button to restore the default values.

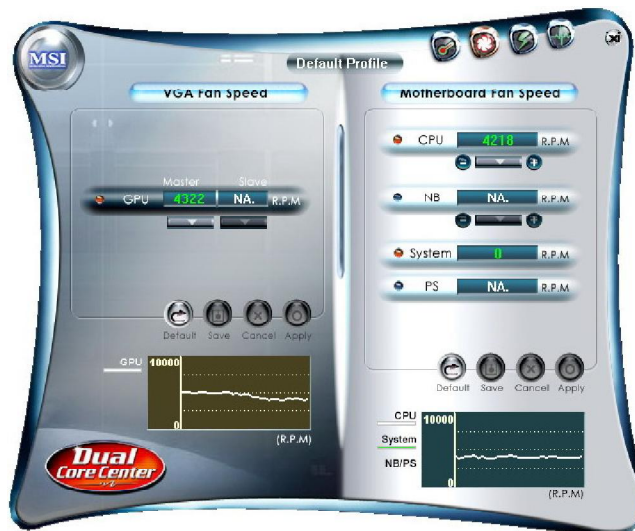

On the underside, it shows the graphs of the fan speed. Only the curves of the item which the button is lit up with red color will be shown.



Important

1. When you set the fan speed manually, please make sure to disabled the "CPU Smart FAN Target" item in the BIOS.
2. In the user profile, clicking the **Save** button can save the changes to it. In the default profile, the Save button is not available.

Temperature

In the **Temperature** sub-menu, you can see temperature status of your system.

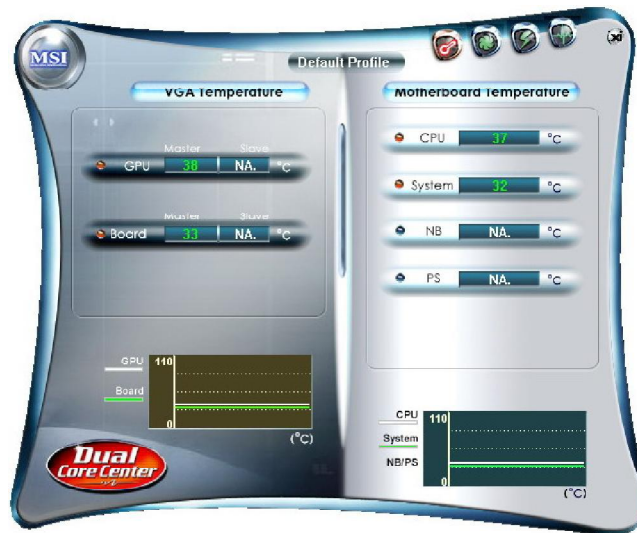



On the underside, it shows the graphs of the temperatures. Only the curves of the item which the button is lit up with red color will be shown.

User Profile

In the **User Profile** sub-menu, click the setting button that besides the user profile bar, and the next screen will appear.



Here you can define the clock/ fan speed/ voltage by your need, click the  button to choose a value quickly, or click the plus  / minus sign  button to increase/ decrease the value.



Dual Core Center

Use the draw bar to set the max system temperature. When the system temperature exceeds the threshold you defined, the system will pop up a warning message and shut down the system.

Use the draw bar to set the minimal fan speed. When the fan speed is lower than the threshold you defined, the system will pop up a warning message.

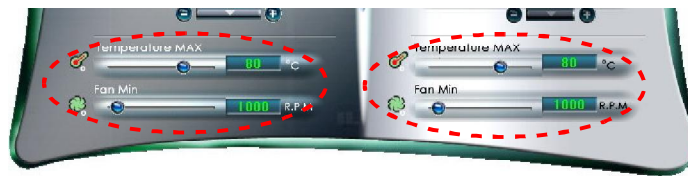

After setting all values you need, you can change the user profile name in the box then click the save button  to save all changes in a profile.



Finally, you can choose the user profile by click the button in the left side and click the Apply button to load the user profile.



Appendix C

SATA RAID

The SB600 and T3 integrate one SATA host controller separately, and support RAID function for performance and reliability.

SATA RAID provides support for RAID 0 (Striping), RAID 1 (Mirroring), RAID 0+1 (Striping & Mirroring). RAID 0 greatly improves hard disk I/O performance by concurrently striping data across multiple drives. RAID 1 makes sure data is not lost if a drive fails as data is simultaneously written to two drives. Drives configured for RAID Striping are said to form a RAID 0 set, while drives configured for RAID Mirroring are said to form a RAID 1 set. RAID 0+1 is implemented as a mirrored array whose segments are RAID 0 arrays. RAID 0+1 has same fault tolerance as mirroring and reduces overhead by striping. It needs at least four drives to form a RAID 0+1.

RAID Configuration

Creating and deleting RAID set and performing other RAID setting up operations are done in the RAID BIOS. During bootup, a screen similar to the one below will appear for about few seconds. Press <Ctrl-F> to enter FastBuild utility.

No Array is defined...
Press <Ctrl-F> to enter Fastbuild (tm) Utility



Important

Be sure to enable the **RAID** function for SATA device in BIOS (please refer the **Integrated Peripherals** section in BIOS) before configuring the Fastbuild Utility.

The FastBuild menu screen will appear. The Main Menu is used to choose the operation to be performed.

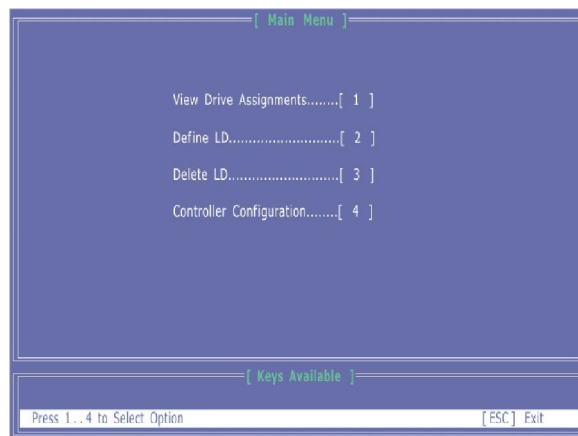

SATA RAID

View Drives Assignments

This window displays the model number, capacities and assignment of the drives physically attached to the SATA host adapter.

Channel: ID	Drive Model	Capacity (MB)	Assignment
1: Mas	WDC WD8001D-00HKA0	80027	
	Extent 1	79960	Free
2: Mas	WDC WD8001D-00HKA0	80027	
	Extent 1	79960	Free

[Keys Available]

[↑] Up [↓] Down [ESC] Exit



Important

Please visit the MSI website (<http://www.msi.com.tw/>) to get the Promise T3 RAID application program for more Promise RAID applications.

Define LD (Creating RAID)

The selection of the RAID configuration should be based upon factors including performance, data security, and the number of drives available. It is best to carefully consider the long-term role of the system and plan the data storage strategy. RAID sets can be created either automatically, or to allow the greatest flexibility, manually.

1. Press **2** on the Main Menu screen to enter the Define LD Menu.
2. Press the arrow keys to highlight an logical drive number you want to define and press Enter to select it.

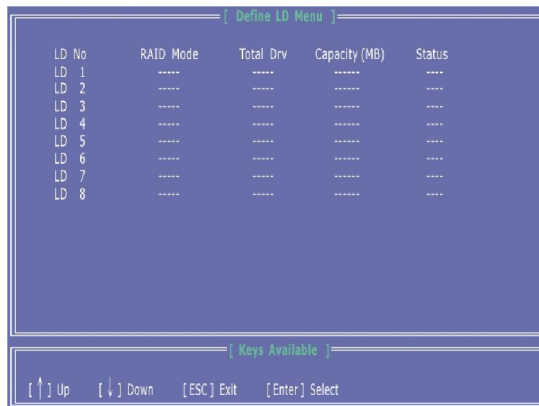

3. On the next screen, use the space key to choose a RAID mode (RAID 0/ 1/ 0+1) and use the arrow key to move to the *Drives Assignments* window.
 - Initialize logical drive, zero the disk drives. RAID 1 or 10 only.

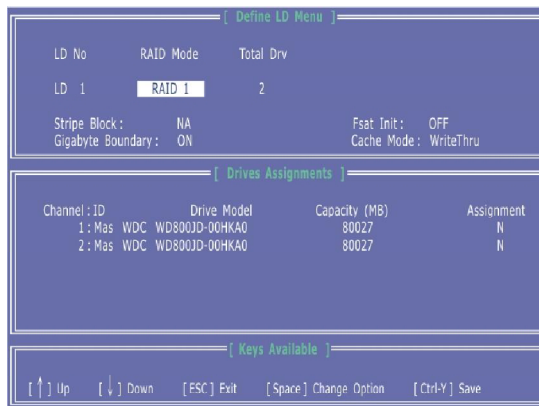

SATA RAID

- Stripe Block Size, the default 64KB is best for most applications. RAID 0 or 10 only.
 - Gigabyte Boundary, allows use of slightly smaller replacement drives.
 - Cache Mode, WriteThru or WriteBack.
4. On the *Drives Assignments* window, use the arrow key to choose the hard drives which you want to make part of the LD, use the space key to change the assignment to "Y". Then press [Ctrl+Y] to save the configuration.

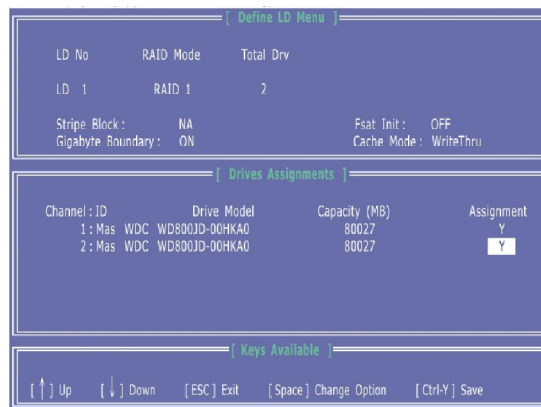

5. A message will show up on the bottom, press any key to save the configuration or press [Ctrl-Y] to allocate the RAID capacity manually.



Important

1. The default capacity is the full capacity of the selected hard drives.
2. If you allocate the first LD capacity manually, you can create second LD with remaining capacity of the selected hard drives.

MS-7376 Mainboard

- The LD creation is done, the screen shows the LD information as below. Press ESC key to the main screen.



The screenshot shows the 'Define LD Menu' utility. It displays a table with the following columns: LD No, RAID Mode, Total Drv, Capacity (MB), and Status. LD 1 is configured with RAID Mode 'RAID 1', Total Drv '2', Capacity (MB) '79000', and Status 'Functional'. LDs 2 through 8 are shown with dashes in all columns. At the bottom, a 'Keys Available' section lists: [↑] Up, [↓] Down, [ESC] Exit, and [Enter] Select.

LD No	RAID Mode	Total Drv	Capacity (MB)	Status
LD 1	RAID 1	2	79000	Functional
LD 2	----	----	----	----
LD 3	----	----	----	----
LD 4	----	----	----	----
LD 5	----	----	----	----
LD 6	----	----	----	----
LD 7	----	----	----	----
LD 8	----	----	----	----

Keys Available:
[↑] Up [↓] Down [ESC] Exit [Enter] Select

- Press ESC key to exit the utility, a message "System is going to REBOOT! Are You Sure?" will display, answer "Y" to exit it and the system will reboot.

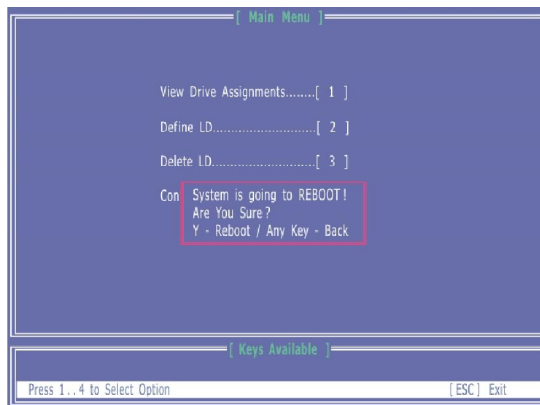

SATA RAID

Delete LD (Deleting RAID)

1. Select "Delete LD" on the main screen.
2. Choose a LD No you want to delete and press "Del" or "Alt+D" delete the RAID set.

LD No	RAID Mode	Total Drv	Capacity (MB)	Status
LD 1	RAID 1	2	79000	Functional
LD 2	----	----	----	----
LD 3	----	----	----	----
LD 4	----	----	----	----
LD 5	----	----	----	----
LD 6	----	----	----	----
LD 7	----	----	----	----
LD 8	----	----	----	----

[Keys Available]

[↑] Up [↓] Down [ESC] Exit [Del or Alt+D] Delete

3. On the next screen, a message will display to inform you, press "Ctrl+Y" to delete the RAID set or other key to abort it. Press "Ctrl+Y" to complete the deletion.

LD No	RAID Mode	Total Drv	Capacity (MB)	Status
LD 1	RAID 1	2	79000	Functional

Stripe Block : NA Cache Mode : WriteThru

Channel : ID	Drive Model	Capacity (MB)
1 : Mas WDC	WD800JD-00HKA0	80027
2 : Mas WDC	WD800JD-00HKA0	80027

Ctrl - Y to delete the ARRAY and MBK, Ctrl-F to delete the ARRAY only, other key to abort

Installing the RAID Driver (for bootable RAID Array)

1. After you complete the RAID BIOS setup, boot from the Windows CD, and the Windows XP Setup program starts.
2. Press **F6** and wait for the Windows Setup screen to appear.



Important

Please follow the instruction below to make a SATA RAID driver for yourself.

1. Insert the MSI CD into the CD-ROM drive.
2. Click the "Browse CD" on the Setup screen.
3. Copy all the contents in the :
 - * **Windows XP driver CD for SB600 RAID:**
\\ATI\\ATIDrv\\SBDrv\\RAID
 - * **Windows Vista driver CD for SB600 RAID:**
\\Chipset\\ATI\\Packages\\Drivers\\SBDrv\\Sb600\\RAID
 - * **Windows XP/ Vista driver CD for Promise RAID:**
\\IDE\\Promise\\FastTrak\\Driver to a formatted floppy disk.
4. The driver disk for RAID controller is done.

3. Insert the floppy that contains the RAID driver, Press the "S" key to select "Specify Additional Device".
4. For Windows Vista:
During the Operating system installation, after selecting the location to install Vista click on "Load Driver" button to install a third party SCSI or RAID driver.
5. When prompted, insert the floppy disk or media (Floppy, CD/DVD Or USB) and press Enter.
6. You should be shown a list of available SCSI Adapters.
7. Select the compatible RAID controller for 32-bit/ 64-bit version system and then press ENTER.
8. The next screen should confirm that you have selected the RAID controller. Press ENTER again to continue.
9. You have successfully installed the RAID driver, and Windows setup should continue.
10. Leave the disk in the floppy drive until the system reboots itself. Windows setup will need to copy the files from the floppy again after the RAID volume is formatted, and Windows setup starts copying files.

Installing the RAID Driver Under Windows (for Non-bootable RAID Array)

1. Insert the MSI CD into the CD-ROM drive.
2. The CD will auto-run and the setup screen will appear.
3. Under the Driver tab, click on **ATI System Driver or Promise PDC42819 Driver** by your need. The ATI System Driver includes RAID Driver.
4. The driver will be automatically installed.



Important

You **must** install the RAID driver to enable RAID.